SERVICE AND INSTALLATION INSTRUCTIONS WITH REPLACEMENT PARTS LIST

LC6000-200 CONTROLLER *Part of the Bard Cooling System*

NOTE: LC6000-200 controller is required for operation when multiple MULTI-TEC[®], FUSION-TEC[®] WR Series and/or MEGA-TEC[®] wall-mount units are used.

Additional information regarding the installation and setup of the LC6000-200 controller and software is included in the system installation instructions shipped inside the wall-mount unit control panel.



Climate Control Solutions

Bard Manufacturing Company, Inc.
Bryan, Ohio 43506
www.bardhvac.com

Manual : 2100-669N
Supersedes: 2100-669M
Date: 4-18-23

CONTENTS

LC6000 Controller Installation..... 5			
LC6000 Controller.....6			
Mounting the LC6000 Controller.....6			
Supply Wiring.....7			
Installing Remote Indoor Sensor(s).....8			
Installing Outdoor Temperature/Humidity Sensor ... 10			
Emergency Off, Emergency Vent and Generator Run Connections11			
Communication Wiring12			
Using the LC6000 Interface..... 15			
LC6000 Controller Interface15			
Main Menu Screens and Password Levels.....15			
Alarms 16			
Alarm Adjustment.....16			
Acknowledging/Clearing Alarms16			
Low Temperature Alarm.....16			
High Temperature Alarm.....16			
High Temperature 2 Alarm.....17			
Emergency Off Alarm Operation17			
Generator Alarm19			
Emergency Vent Alarm Operation.....20			
Zone Unit Alarm21			
Humidity Alarm21			
Alarm Grouping22			
Control Operation 24			
Temperature Control.....24			
Setpoint Adjustment24			
Indoor Temperature Averaging24			
Comfort Mode.....24			
Staging25			
Staging Order25			
Staging Type25			
Staging Delay27			
Maximum Number of Units Running.....28			
Rotation.....28			
Humidity Control29			
Staged Dehumidification29			
Humidification.....30			
Continuous Blower.....31			
Continuous Blower Custom Configuration31			
Additional Information..... 32			
LC6000 Menus/Screens32			
Main Menu.....32			
Status Screen.....32			
Quick Menu32			
Additional Programming.....33			
Changing to Celsius33			
Configuring Number of Units.....33			
Calibrating Sensors.....33			
Clearing Alarm Logs34			
Configuring Free Cooling.....34			
Enabling High Sensible Operation34			
LC6000 Controller and Unit Feature Matrix.....39			
LC6000 I/O Input Matrix40			
LC6000 I/O Output Matrix.....40			
Troubleshooting 41			
8403-079 Remote Indoor Temp/Humidity Sensor41			
Remote Indoor Temp/Humidity Sensor Orientation.. 44			
8301-090 Outdoor Temp/Humidity Sensor45			
LC6000 Replacement Parts List..... 46			
FIGURES AND TABLES			
Figure 1 Typical LC6000-200 Component Location 5			
Figure 2 LC6000 Fused Power Supply Terminals.....6			
Figure 3 LC6000 Controller Supply Wiring.....7			
Figure 4 Controller Grounding Posts7			
	Figure 5	Remote Indoor Temperature/Humidity Sensor Installation8	
	Figure 6	Additional Remote Sensor Installation.....9	
	Figure 7	Remote Outdoor Temperature/Humidity Sensor Installation10	
	Figure 8	Emergency Off, Emergency Vent and Generator Run Connections11	
	Figure 9	Communication Wiring: Termination at the Controller.....12	
	Figure 10	Communication Wiring (Daisy Chain).....13	
	Figure 11	Communication Wiring (Alt. Method).....13	
	Figure 12	Placement of Communication Filters14	
	Figure 13	LC6000 Controller Display and Interface15	
	Figure 14	Adjust Alarm Setpoints16	
	Figure 15	Adjust Alarm Remote Notification Relay Output Direction16	
	Figure 16	Adjust Emergency Off, Emergency Vent or Generator Alarm Input Direction.....18	
	Figure 17	Enable Zone Emergency Off/ Set Alarm Reset18	
	Figure 18	Adjust Alarm Remote Notification Relay Output Direction18	
	Figure 19	Adjust Units Running When Generator Is Active.....19	
	Figure 20	Enable Zone Emergency Ventilation.....20	
	Figure 21	Adjust Zone Alarm Configuration21	
	Figure 22	Adjust Humidity Alarm Setpoints22	
	Figure 23	Option 1: Inputs Referencing Voltage22	
	Figure 24	Option 2: Inputs Referencing Ground23	
	Figure 25	Option 3: Isolation Relays23	
	Figure 26	Cooling and Heating Setpoints.....24	
	Figure 27	Change Indoor Temperature Averaging Type... 24	
	Figure 28	Adjust Staging Type or Order27	
	Figure 29	Staging Maximum Number of Units Running ..28	
	Figure 30	Rotation28	
	Figure 31	Humidity Control Setpoints30	
	Figure 32	Dehumidification Types.....30	
	Figure 33	Enabling Humidifier30	
	Figure 34	Continuous Blower Status31	
	Figure 35	Continuous Blower Custom Configuration..... 31	
	Figure 36	MULTI-TEC Unit Info Screen32	
	Figure 37	FUSION-TEC WR Series Unit Info Screen..... 32	
	Figure 38	MEGA-TEC Unit Info Screen.....32	
	Figure 39	Changing to Celsius.....33	
	Figure 40	Clearing LC6000 Alarm Logs.....34	
	Figure 41	Configuring Free Cooling.....34	
	Figure 42	Enabling High Sensible Operation.....35	
	Figure 43	LC6000-200 Wiring Diagram38	
	Figure 44	8403-079 Sensor41	
	Figure 45	Current Sensor Orientation44	
	Figure 46	Earlier Sensor Orientation44	
	Figure 47	8301-090 Sensor45	
	Table 1	LC6000 Passwords (Defaults).....15	
	Table 2	FIFO: First In First Out25	
	Table 3	LIFO: Last In First Out.....26	
	Table 4	Demand: Return Air Demand Cooling26	
	Table 5	Demand: Return Air Demand Heating.....27	
	Table 6	Software Versioning Guide.....33	
	Table 7	LC6000 Status Messages.....33	
	Table 8	LC6000-200 Terminal Block Index36	
	Table 9	LC6000-200 to Sensor Connection Index..... 37	
	Table 10	8403-079 Sensor: Temp/Resistance42	
	Table 11	8403-079 Sensor: Voltage/Humidity43	
	Table 12	8301-090 Sensor: Temp/Resistance45	

GENERAL INFORMATION

Cooling System

This Bard cooling system is composed of MULTI-TEC, FUSION-TEC WR Series and/or MEGA-TEC wall-mounted air conditioners matched with an LC6000 supervisory controller, th-Tune single-unit controller or Bard PGD/PGDx stand-alone display. (th-Tune can only be used with MULTI-TEC units and PGDx can only be used with MEGA-TEC units.) If only one wall-mounted air conditioner is being used, it can be matched with either the LC6000 or a PGD/PGDx stand-alone display (if applicable). If more than one wall-mount unit is installed, the LC6000 controller must be matched with the air conditioning units. The wall-mount units are specifically engineered for equipment cooling applications. All three wall-mount models can be used together with one LC6000 controller but must be limited to the same model within each zone.

NOTE: The LC6000 controller and MULTI-TEC, FUSION-TEC WR Series and MEGA-TEC wall-mount units are designed specifically to work together. The controller cannot run other brands of systems, nor can other controllers run the MULTI-TEC, FUSION-TEC WR Series or MEGA-TEC wall-mount units. They are a complete system, and must be used together.

LC6000-200 Series Controller and Accessories Included with Controller

(1) LC6000 Programmable Logic Controller

(1) TEC-EYE™ Hand-Held Diagnostic Tool
Bard P/N 8301-059

(1) Remote Temperature/Humidity Sensor¹
Bard P/N 8403-079

(1) 35' 5-Wire 18 Gauge Shielded Cable

(2) Communication EMI Filters
Bard P/N 8301-055

Optional Sensors:

Outside Air
Temperature/Humidity Sensor
Bard P/N 8301-090

Remote
Temperature/Humidity Sensor¹
Bard P/N 8403-079

Remote
Temperature Only Sensor
Bard P/N 8301-058

¹ One remote temperature/humidity sensor is included with the LC6000 controller. If the site in which the LC6000 controller will be used has more than one zone (maximum three zones per LC6000), additional remote temperature/humidity sensors (one sensor per zone) will need to be purchased and installed in the additional zones. One additional temperature-only sensor (Bard P/N 8301-058) may also be used in Zone 1 but will also need to be purchased separately. Additional temperature/humidity sensors require field-supplied 5-wire 18 gauge shielded cable. Temperature-only sensors require field-supplied 2-wire 18 gauge shielded cable.

The equipment covered in this manual is to be installed by factory trained and certified, experienced service and installation technicians.

These instructions should be carefully read before beginning the installation. Note particularly any tags and/or labels attached to the equipment.

While these instructions are intended as a general recommended guide, they do not supersede any national and/or local codes in any way. Authorities having jurisdiction should be consulted before the installation is made. See **Additional Publications** for information on codes and standards.

Shipping Damage

Upon receipt of equipment, the cartons should be checked for external signs of shipping damage. If damage is found, the receiving party must contact the last carrier immediately, preferably in writing, requesting inspection by the carrier's agent.

Additional Publications

These publications can help when installing the air conditioner. They can usually be found at the local library or purchased directly from the publisher. Be sure to consult the current edition of each standard.

- National Electrical CodeANSI/NFPA 70
- Standard for the Installation of Air Conditioning and Ventilating SystemsANSI/NFPA 90A
- Standard for Warm Air Heating and Air Conditioning SystemsANSI/NFPA 90B
- Load Calculation for Residential Winter and Summer Air Conditioning ACCA Manual J
- Duct Design for Residential Winter and Summer Air Conditioning and Equipment Selection ACCA Manual D

For more information, contact these publishers:

Air Conditioning Contractors of America (ACCA)
1712 New Hampshire Ave. N.W.
Washington, DC 20009
Telephone: (202) 483-9370 Fax: (202) 234-4721

American National Standards Institute (ANSI)
11 West Street, 13th Floor
New York, NY 10036
Telephone: (212) 642-4900 Fax: (212) 302-1286

American Society of Heating, Refrigeration and Air Conditioning Engineers, Inc. (ASHRAE)
1791 Tullie Circle, N.E.
Atlanta, GA 30329-2305
Telephone: (404) 636-8400 Fax: (404) 321-5478

National Fire Protection Association (NFPA)
Batterymarch Park
P. O. Box 9101
Quincy, MA 02269-9901
Telephone: (800) 344-3555 Fax: (617) 984-7057

ANSI Z535.5 Definitions:

DANGER: Indicate[s] a hazardous situation which, if not avoided, will result in death or serious injury. The signal word "DANGER" is to be limited to the most extreme situations. DANGER [signs] should not be used for property damage hazards unless personal injury risk appropriate to these levels is also involved.

WARNING: Indicate[s] a hazardous situation which, if not avoided, could result in death or serious injury. WARNING [signs] should not be used for property damage hazards unless personal injury risk appropriate to this level is also involved.

CAUTION: Indicate[s] a hazardous situation which, if not avoided, could result in minor or moderate injury. CAUTION [signs] without a safety alert symbol may be used to alert against unsafe practices that can result in property damage only.

NOTICE: [this header is] preferred to address practices not related to personal injury. The safety alert symbol shall not be used with this signal word. As an alternative to "NOTICE" the word "CAUTION" without the safety alert symbol may be used to indicate a message not related to personal injury.



NOTICE

It is important to check the software version during installation to ensure that the latest version has been installed. Current software versions and installation instructions are available on the Bard website at <http://www.bardhvac.com/software-download/>

LC6000 CONTROLLER INSTALLATION

FIGURE 1
Typical LC6000-200 Component Location

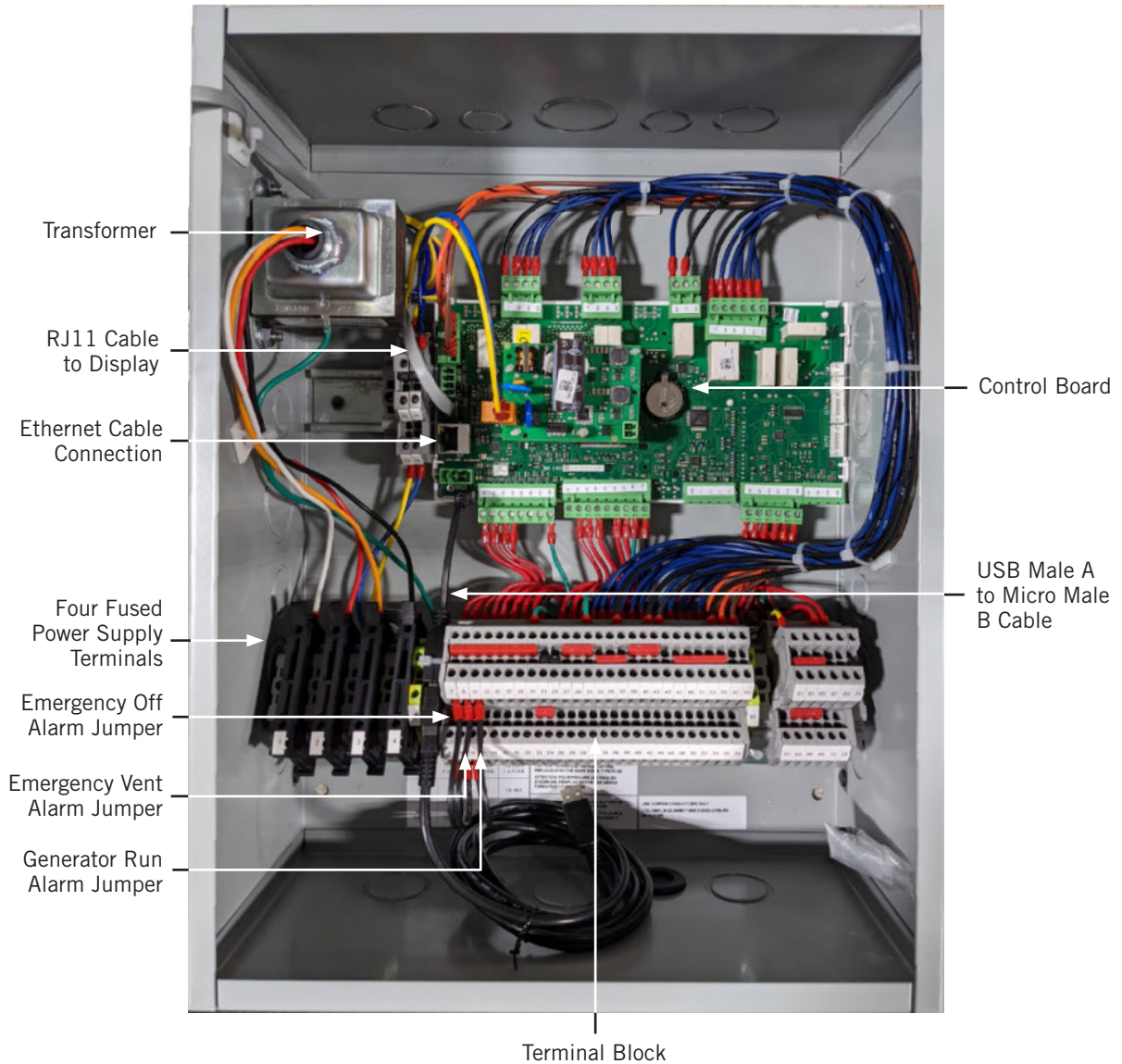

WARNING

Electrical shock hazard.

Disconnect VAC power supplies before servicing.

Failure to do so could result in electric shock or death.

IMPORTANT: When working with circuit board components, Bard recommends the use of an anti-static wrist strap to prevent static electricity shorts to electronic controls.

LC6000 Controller

The LC6000 controller is part of this air conditioning system. It is used to control up to 14 wall-mount air conditioners from one controller. The microprocessor control provides an easy-to-read interface with large LCD graphical display. It provides control for redundancy for the structure and equal wear on all units.

Conduit is recommended for all wiring. Route communication wiring and power supply wiring in their own separate conduits.

The LC6000 controller is not weatherproof and is intended for use in a weathertight structure.

IMPORTANT: When connecting this product from a remote location, ensure that the network connection is secure and reliable.

Mounting the LC6000 Controller

The dimensions of the LC controller are 16" x 12" x 6".

Because the LC6000 controller utilizes a remote temperature sensor as opposed to one located in the controller box, the controller itself can be installed in any indoor location that is suitable, preferably at eye level. Four (4) mounting holes are provided for mounting to the wall and holes for conduit connections are provided in the base, sides and top of the controller.

The LC6000 controller includes four fused power supply terminals in the terminal block. Before connecting wires to the terminal block, confirm that the fuse in each of the four fuse holders is in the proper position (active) as shown in Figure 2.

FIGURE 2
LC6000 Fused Power Supply Terminals

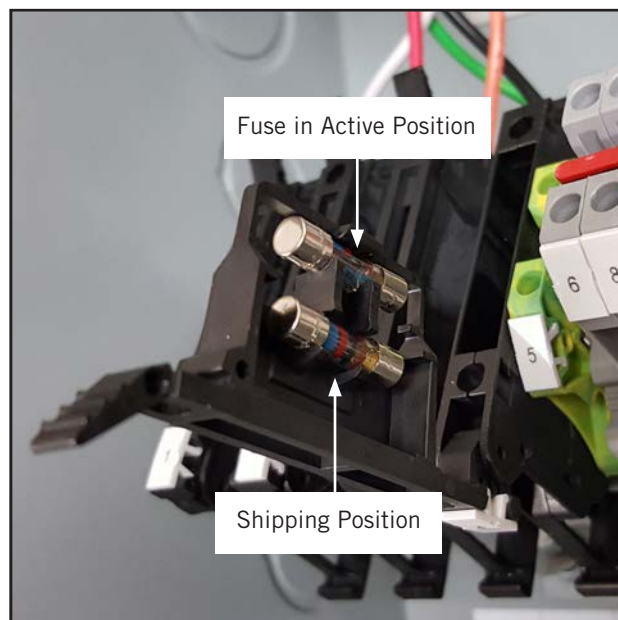

Supply Wiring

The LC6000 controller is powered by 120, 208 or 240 volts from the shelter. Field-supplied supply wiring should be minimum 16 gauge, maximum 14 gauge (see Figure 3). A reliable earth ground must be connected in addition to any grounding from conduit. Grounding bolts and nuts are included with the controller for this purpose; a 2 hole grounding lug must be field supplied. Install as shown in Figure 4. **Failing to ground the controller box properly could result in damage to the equipment.**

FIGURE 3
LC6000 Controller Supply Wiring

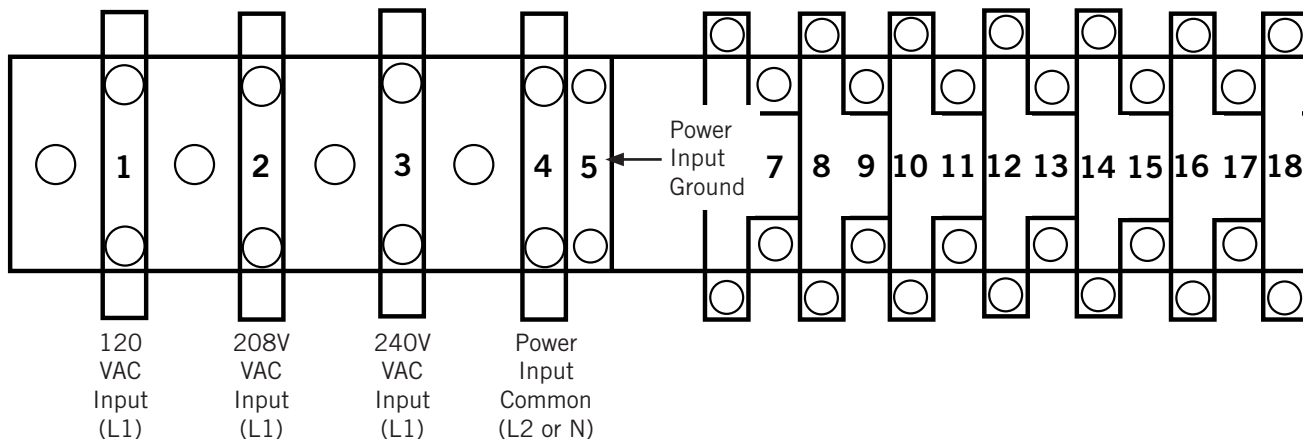
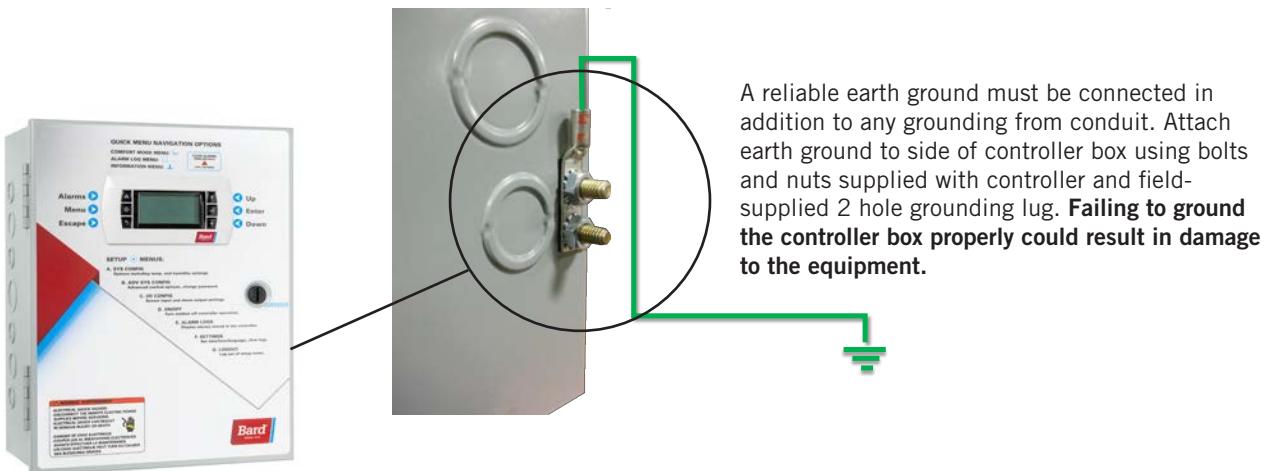

FIGURE 4
Controller Grounding Posts



Installing Remote Indoor Temperature/Humidity Sensor(s)

One remote indoor temperature/humidity sensor and 35' of 18 gauge 5-conductor shielded cable is included with the controller. This sensor must be installed for proper operation. Mount the temperature/humidity sensor in a location least likely to be affected by open doors, rack-mounted fans, radiant heat sources, etc. Locating the sensor between both return grilles is often the best location, but every installation is unique. Location height should be approximately 60" above the floor. The sensor should be installed on a 2" x 4" junction box to allow for control wire conduit. Use shielded cable to connect to controller. The maximum cable length to connect the temperature/humidity sensor to the LC6000 is 98'.

FIGURE 5
Remote Indoor Temperature/Humidity Sensor Installation

1. Connect wires from the 18 gauge shielded cable to terminals #12, #13, #18, #19 and #22.

TB#	Wire Mark	Sensor	Description
18	B6	NTC OUT	Indoor Remote Sensor (Zone 1)
19	GND	NTC OUT	Ground
12	B2	OUT H	Remote Indoor Humidity Sensor: 0-1 VDC (Zone 1)
13	GND	M (GO)	Ground
22	+VDC	+ (G)	Power for B2

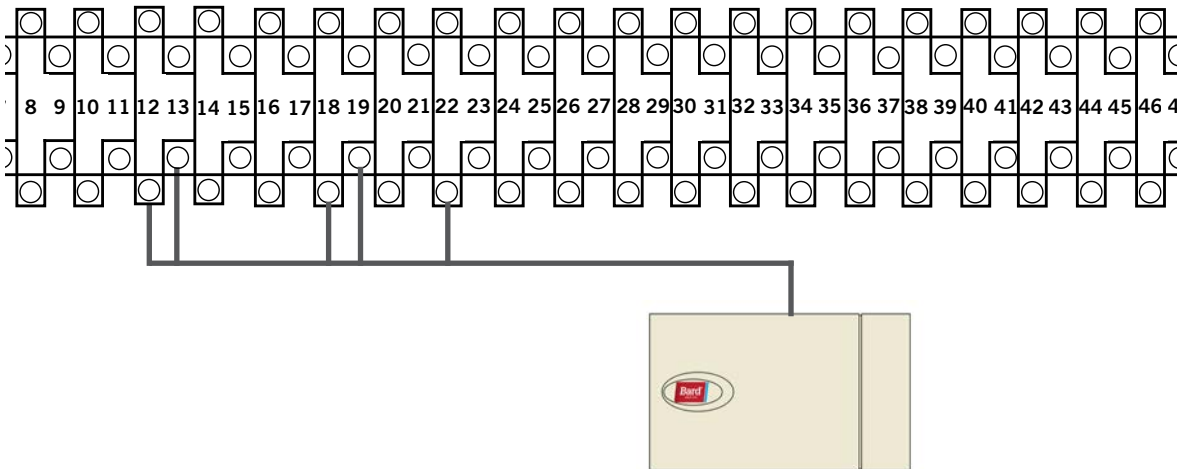

2. Connect the other end of the shielded cable to the sensor terminals. Be sure wires are connected to proper terminals as shown in table above.

Sensor jumpers need to be positioned for 0-1 V. With sensor oriented as shown in image to right, move both jumpers to right position (DP1 and DP2 set to OFF). **This applies to all indoor temperature/humidity sensors connected to the LC controller.** See illustration mounted inside of sensor cover for further detail on jumper position.

Earlier versions of this sensor may be mounted in a different orientation which would affect the positioning of the sensor jumpers. See page 44 for additional information on sensor orientation.

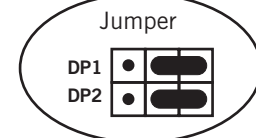
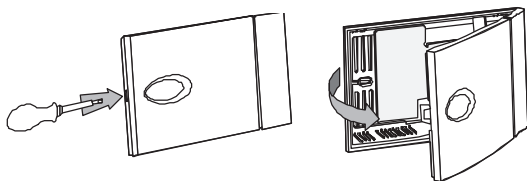
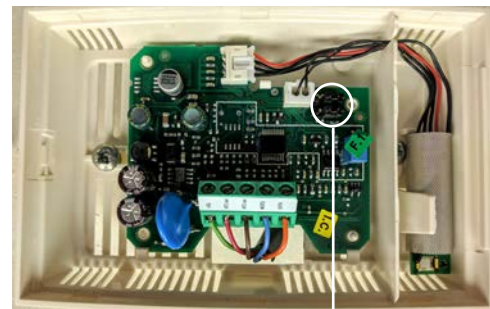

For proper operation, the remote indoor temperature/humidity sensor (and any additional sensors) must be configured properly with the controller as shown in Step 2 on page 8. An additional remote indoor temperature-only sensor can be purchased and installed in Zone 1. If the site in which the LC6000 controller will be used has more than one zone (maximum three zones per LC6000), additional remote temperature/humidity sensors (one per zone) will need to be purchased and installed in the additional zones. All installed sensors must be enabled in the controller menu (see **Configure Sensors** in system installation instructions included with the wall-mount unit).

FIGURE 6
Additional Remote Temperature and Temperature/Humidity Sensor Installation

One additional temperature sensor can be added to Zone 1 and additional temperature/humidity sensors may be added to Zones 2 and 3 (one per zone). **Be sure the sensors are connected to the proper terminals on the terminal block and sensor as listed below.** The maximum cable length to connect temperature or temperature/humidity sensors to the LC6000 is 98'.



Zone 1:
Optional Remote
Temperature Sensor
Terminals 20 & 21*

TB#	Wire Mark	Description
20	B7	Indoor Remote Sensor (Zone 1 – optional)
21	GND	Ground

* The two wire connections for the optional remote temperature sensor are not polarity sensitive.

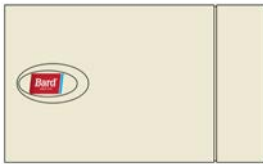

Zone 2:
Optional Remote
Temperature/Humidity Sensor
Terminals 26, 27, 14, 15 & 23

IMPORTANT: Note jumper position in Figure 5

TB#	Wire Mark	Sensor	Description
26	B8	NTC OUT	Indoor Remote Sensor (Zone 2)
27	GND	NTC OUT	Ground
14	B3	OUT H	Remote Indoor Humidity Sensor: 0-1 VDC (Zone 2)
15	GND	M (GO)	Ground
23	+VDC	+ (G)	Power for B3



Zone 3:
Optional Remote
Temperature/Humidity Sensor
Terminals 28, 29, 16, 17 & 24

IMPORTANT: Note jumper position in Figure 5

TB#	Wire Mark	Sensor	Description
28	B9	NTC OUT	Indoor Remote Sensor (Zone 3)
29	GND	NTC OUT	Ground
16	B4	OUT H	Remote Indoor Humidity Sensor: 0-1 VDC (Zone 3)
17	GND	M (GO)	Ground
24	+VDC	+ (G)	Power for B4

Zones 2 and 3 can also use temperature-only sensors in place of the temperature/humidity sensors. Zone 2 will connect to TB# 26 and 27. Zone 3 will connect to TB# 28 and 29. The wire connections for the temperature-only sensors are not polarity sensitive.

Installing Optional Outdoor Temperature/Humidity Sensor

One optional outdoor temperature/humidity sensor (8301-090) can be installed. Follow the manufacturer's mounting instructions. Use 18 gauge 5-conductor shielded cable to connect to controller. The maximum cable length to connect the temperature/humidity sensor to the LC6000 is 98'.

FIGURE 7
Remote Outdoor Temperature/Humidity Sensor Installation

1. Connect wires from the 18 gauge shielded cable to terminals #65, #66, #67, #70 and #71.

TB#	Wire Mark	Sensor	Description
70	B12	4	Remote Outdoor Temperature Sensor
71	ND	5	Ground
67	B11	1	Remote Outdoor Humidity Sensor: 0-10 VDC
66	GND	3	Ground
65	+VDC	2	+VDC

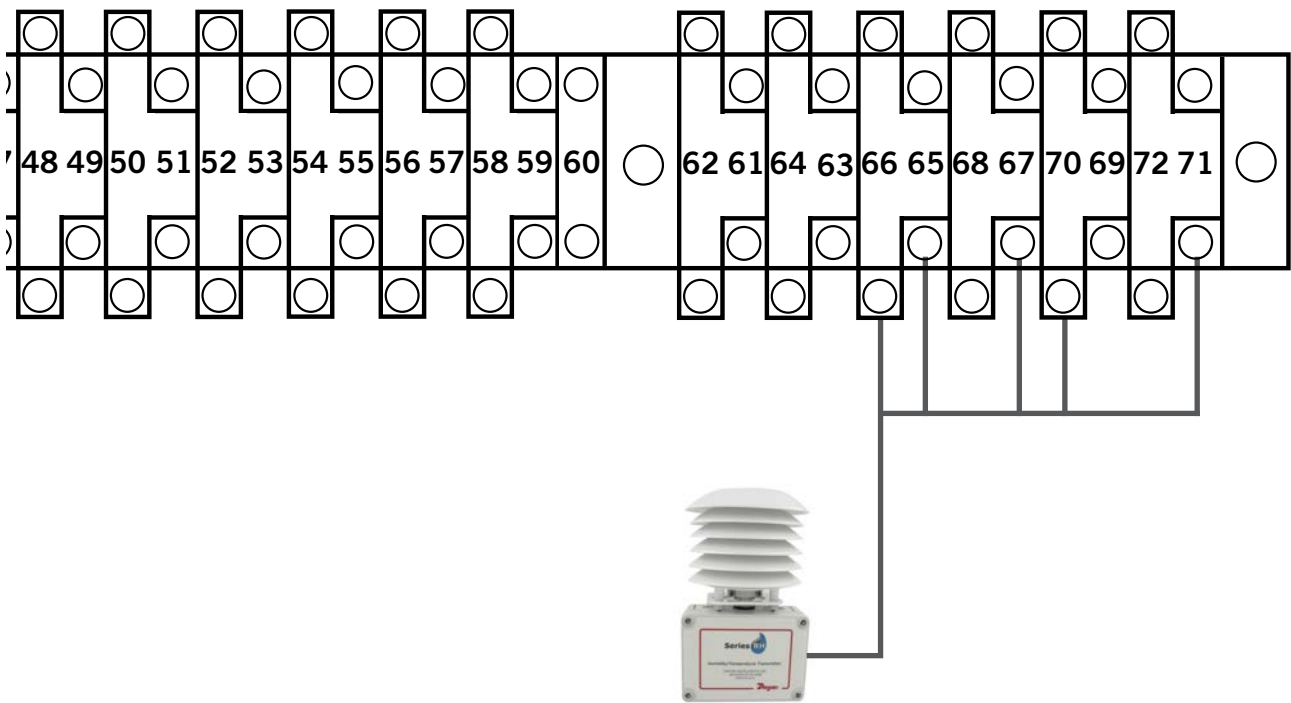

2. Connect the other end of the shielded cable to the sensor terminals. Be sure wires are connected to proper terminals as shown in table above.

Emergency Off, Emergency Ventilation and Generator Run Connections

The LC6000-200 controller is shipped with emergency off, emergency ventilation and generator run contacts. There are factory-installed jumpers across terminals #6 and #7 (emergency off), #8 and #9 (emergency ventilation) and #10 and #11 (generator run). Remove the factory-installed jumpers before making the connections.

FIGURE 8

LC6000-200 Series Connection for Emergency Off, Emergency Ventilation and Generator Run (If Applicable)

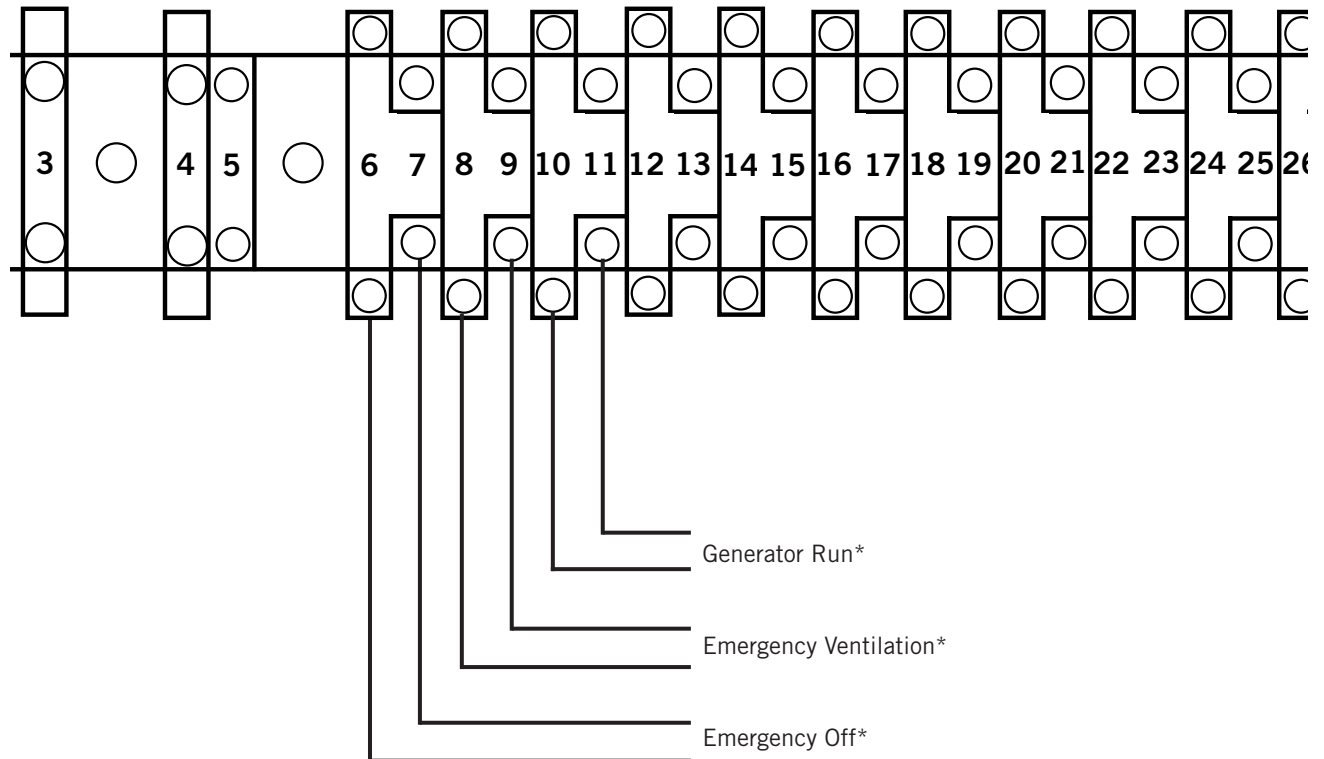

* Normally closed (NC) contacts required.

By default:
Closed = No Alarm
Open = Alarm

Communication Wiring

The steps outlined on the following pages show how to connect the communication wiring to the LC controller. Communication wire connections to the wall-mount unit vary with the different units. See the system installation instructions included with the wall-mount unit for information on connecting the communication wiring to the wall-mount unit(s).

FIGURE 9
Communication Wiring: Termination at the Controller

1. Using the field-provided shielded cable, make a small service loop after entering the controller and attach the provided EMI filter at the intersection of the loop.

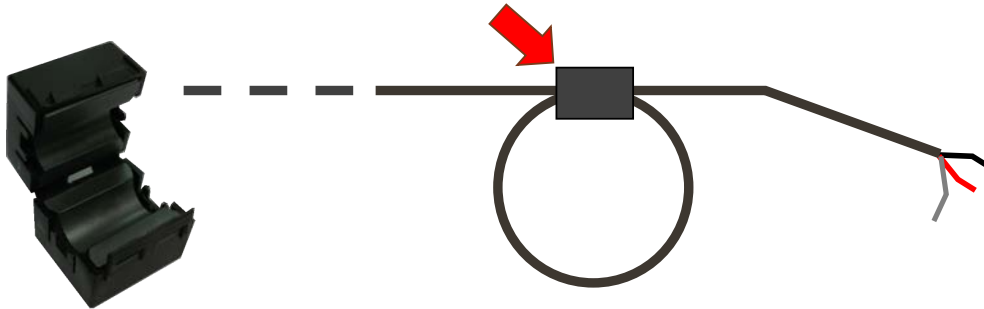

2. Connect one wire to terminal #56 (negative), the other wire to terminal #57 (positive) and the drain wire to ground terminal #60.

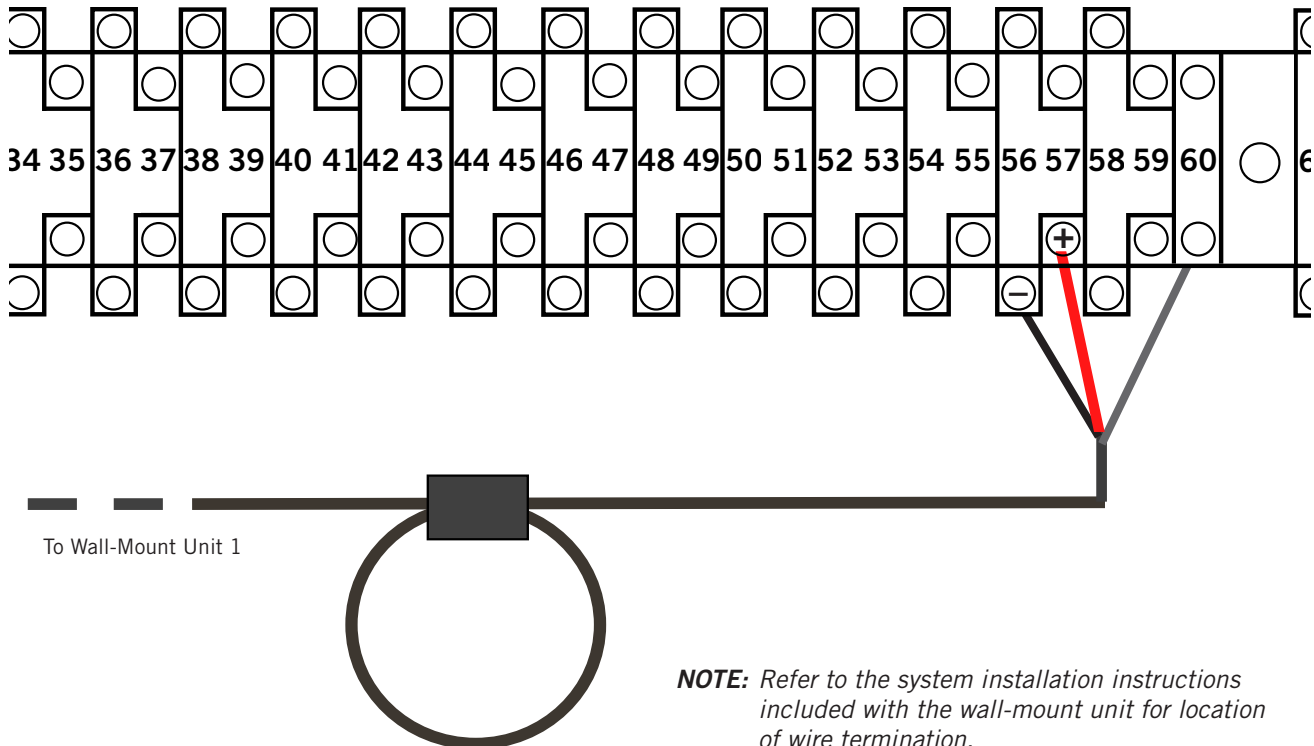

NOTE: Refer to the system installation instructions included with the wall-mount unit for location of wire termination.

Connect the communication wiring from the controller to the wall-mount units in the manner shown in Figures 10, 11 or 12. **The daisy chain does not need to follow the addressing order.** The communication wire should be 2-wire, 18 gauge shielded cable with drain. Any color can be used. Be sure to match "+" and "-" symbols on controller terminal blocks to prewired unit control terminal block. Attach communication wire filters as shown in Figures 10, 11 or 12. **Do not run communication wiring in same conduit as supply wiring. Route communication wiring and power supply wiring in their own separate conduits.**

The wall-mount units may not look the same as those depicted in the figures but these directions apply to all units connected to the LC6000-200 controller.

**FIGURE 10
Communication Wiring (Daisy Chain Method)**

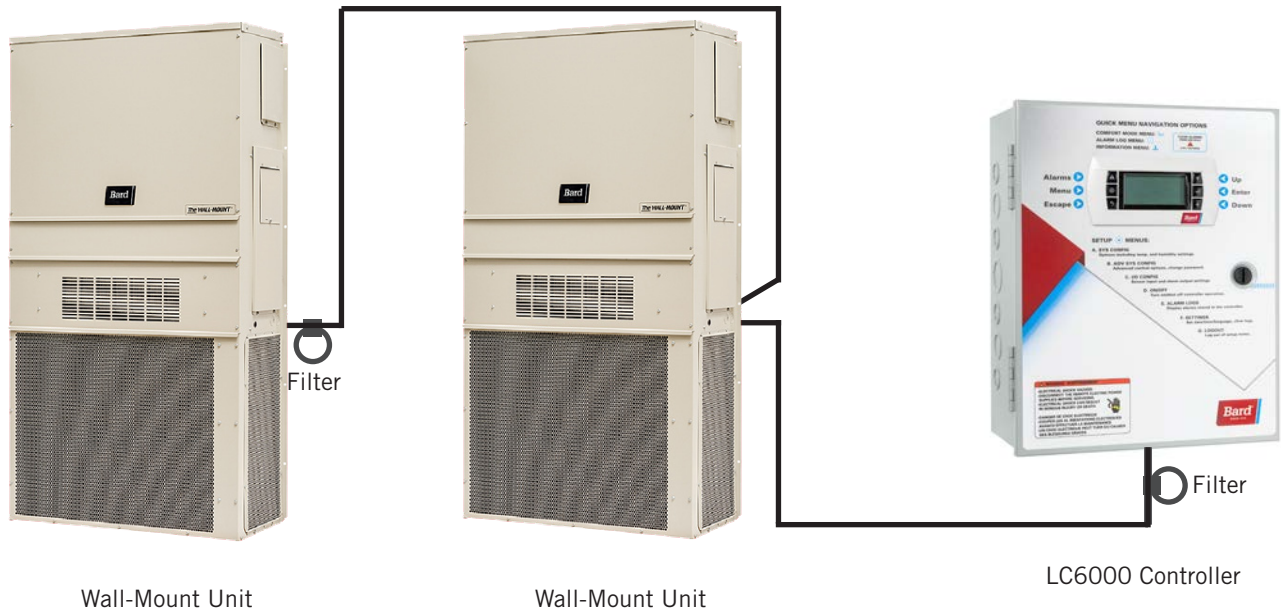

In addition to the "daisy chain" method of connecting the communication wiring shown in Figure 10, the wall-mount units can also be connected in the manner shown in Figure 11. If connecting wall-units this way, be sure to place the communication wire filters in the positions shown in Figure 11. See Figure 12 on page 14 for more information on the correct placement of the communication wire filters depending on the wiring method used.

**FIGURE 11
Communication Wiring (Alternate Method)**

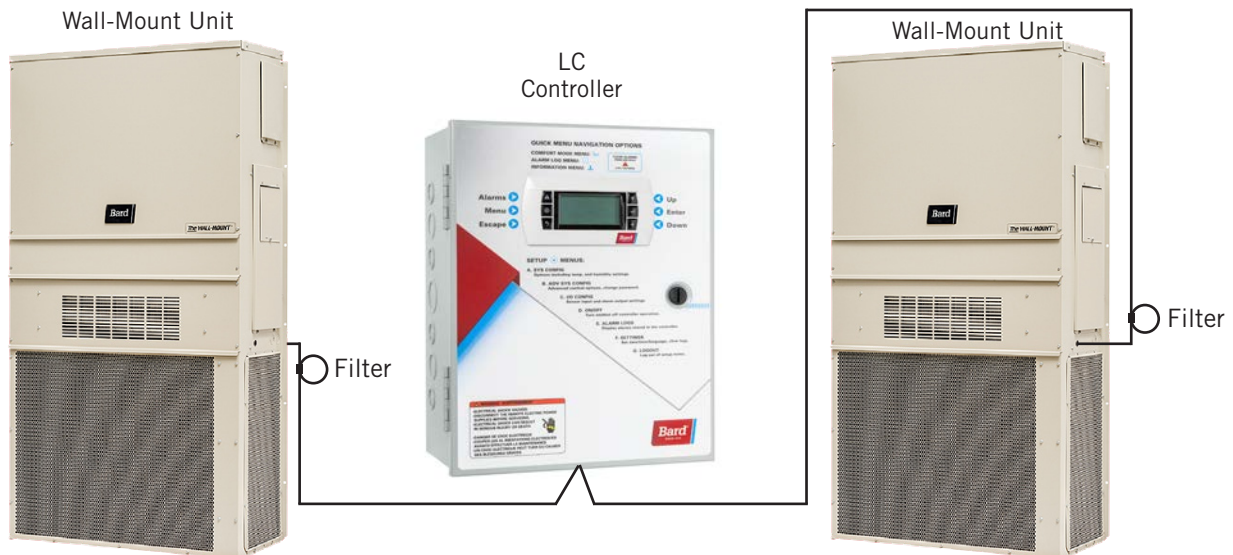
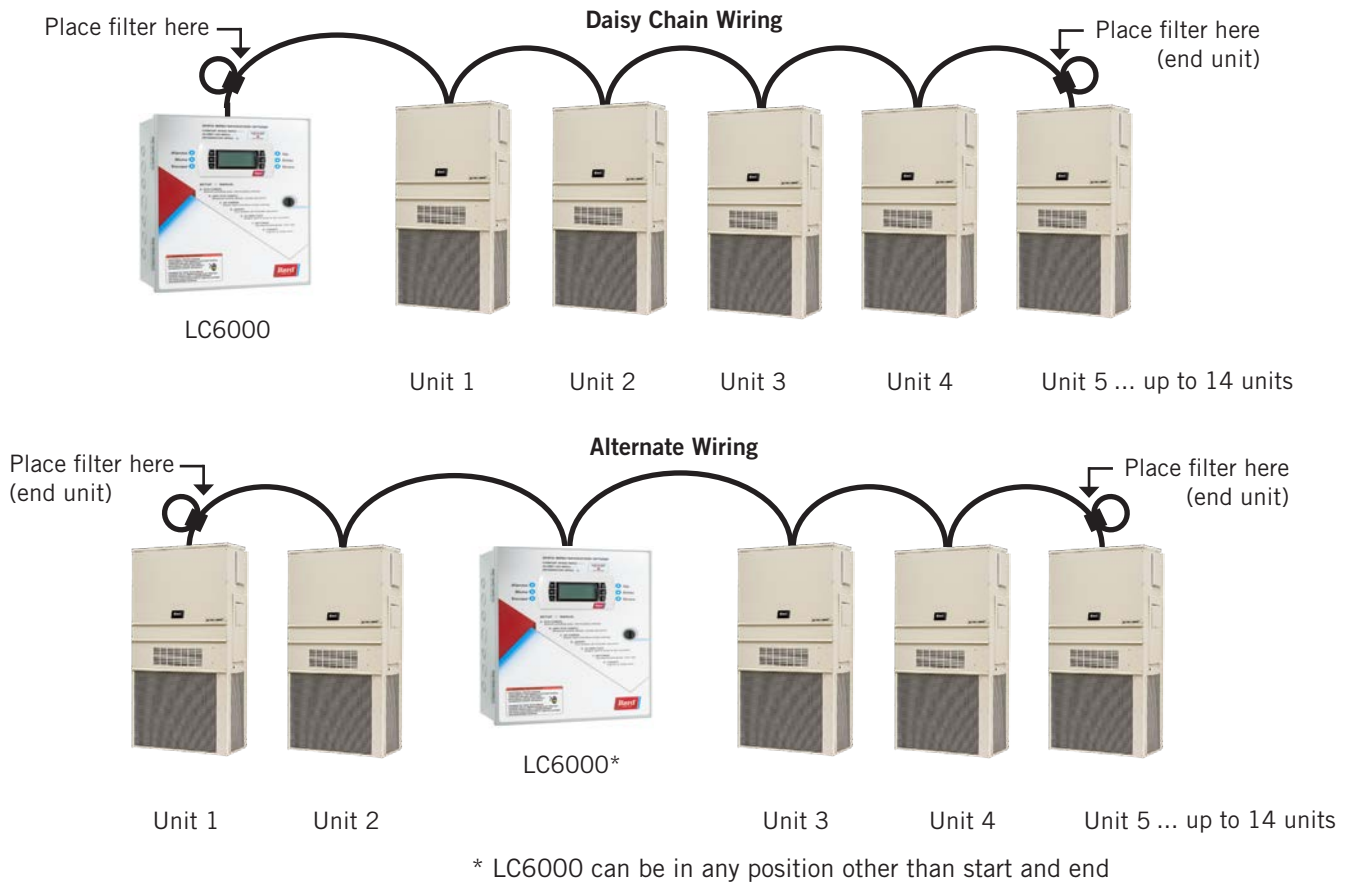

FIGURE 12
Placement of Communication Wire Filters (Daisy Chain and Alternate Methods)



NOTE: Line filters can be on either the unit or controller, whichever device is on the end of the chain. No matter how many units there are, the two end devices will only have ONE communication cable, whereas the center devices will all have TWO (as shown above). Maximum two wires in each terminal. Filters go inside the unit or controller; shown out of unit above for identification only.

USING THE LC6000 INTERFACE

FIGURE 13
LC6000 Controller Display and Interface (Status Screen Shown)

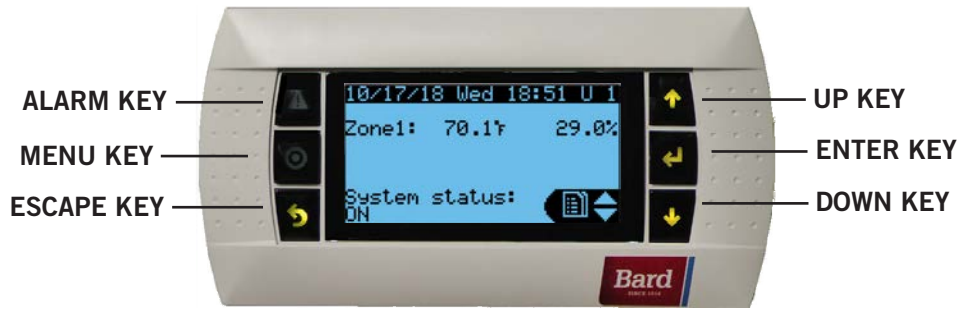

- ALARM KEY**
Allows viewing of active alarms
Silences audible alarms
Resets active alarms
- MENU KEY**
Allows entry to Main Menu
- ESCAPE KEY**
Returns to previous menu level
Cancels a changed entry

- UP KEY**
Steps to next screen in the display menu
Changes (increases) the value of a modifiable field
- ENTER KEY**
Accepts current value of a modifiable field
Advances cursor
- DOWN KEY**
Steps back to previous screen in the display menu
Changes (decreases) the value of a modifiable field

LC6000 Controller Interface

The microprocessor control used in MULTI-TEC, FUSION-TEC WR Series and MEGA-TEC wall-mount air conditioners allows for complete control and monitoring through the use of the LC6000 controller.

The menu driven interface provides users the ability to scroll through two menu levels: Quick Menu and Main Menu. The menus permit the user to easily view, control and configure the unit.

The controller is completely programmed at the factory; therefore, most applications will require no field set-up. However, the default setpoints and their ranges are easily viewed and adjusted from the controller display. The program and operating parameters are permanently stored on FLASH-MEMORY in case of power failure. The controller is designed to manage temperature levels to a user-defined setpoint via control output signals to the wall-mount air conditioning system.

TABLE 1
LC6000 Passwords (Defaults)

User	2000
Technician	1313
Engineer	9254
Use UP or DOWN keys and ENTER key to enter password	

Main Menu Screens and Password Levels

- A** System Config
 - General: User (2000)
 - Zone 1: User (2000)
 - Zone 2: User (2000)
 - Zone 3: User (2000)
- B** Adv Sys Config: Technician (1313)
- C** I-O Config: Technician (1313)
- D** On/Off: User (2000)
- E** Alarm Logs: User (2000)
- F** Settings
 - Date/Time: Technician (1313)
 - Language: User (2000)
 - Network Config: Technician (1313)
 - Serial Ports: Technician (1313)
 - Initialization
 - Clear Logs: User (2000)
 - System Default: Engineer (9254)
 - Restart: User (2000)
 - Parameter Config: Engineer (9254)
 - Alarm Export: User (2000)
- G** Logout: Used to log out of the current password level. Entering back into the menu requires a password.

See **Additional Information** section beginning on page 32 for more information on LC6000 controller menus and screens.

ALARMS

NOTE: Screenshots shown in this manual reflect default settings (when applicable).

Alarm Adjustment

Acknowledging/Clearing Alarms

Alarm conditions activate a red LED indicator that backlights the ALARM function key. As an option, an alarm condition may also be enunciated by an audible alarm signal. An alarm is acknowledged by pressing the ALARM key. This calls up alarm display screen(s) that provide a text message detailing the alarm condition(s). After an alarm condition is corrected, the alarm can be cleared by pressing the ALARM key for 3 seconds.

Low Temperature Alarm

If the lowest temperature sensor value in a zone is below the low temperature setpoint, an alarm will be generated for that zone. Additionally, a relay output will be actuated from the LC controller to provide remote notification of the event.

NOTE: This alarm is per zone. If each zone is meant to operate within the same alarm parameters, each zone will need to be set accordingly.

To adjust the low temperature alarm setpoint:

1. Press MENU key to go to the Main Menu screen.
2. Use UP or DOWN keys and ENTER key to enter USER password 2000.
3. Press UP or DOWN keys to scroll to **Sys Config**; press ENTER key.
4. Press UP or DOWN keys to scroll to **Zone 1, Zone 2** or **Zone 3**; press ENTER key.
5. Press UP or DOWN keys to scroll to **Alarm Setpoints A2-9** (Zone 1), **Alarm Setpoints A3-9** (Zone 2) or **Alarm Setpoints A4-9** (Zone 3).
6. Press ENTER key to scroll to the variable labeled **Low Temp** (see Figure 14).
7. Press UP or DOWN keys to adjust setpoint.

FIGURE 14
Adjust Alarm Setpoints

Alarm Setpoints A2-9	
Zone 1 Temp. Alarms	
Low Temp:	45F
High Temp:	85F
High Temp 2:	90F
Alarm Delay:	10s

To change the direction of the remote notification relay output:

1. Press MENU key to go to the Main Menu screen.
2. Use UP or DOWN keys and ENTER key to enter USER password 2000.
3. Press UP or DOWN keys to scroll to **IO Config**; press ENTER key.
4. Press UP or DOWN keys to scroll to **Digital Out Config C3**.
5. Press ENTER key to scroll to the variable in the table that intersects **LoTemp** and **Dir** (see Figure 15).
6. Press UP or DOWN key to change direction.

The low temperature notification relay has dry contacts. The **Dir**, direction, is the position of the relay without a low temperature event. **NO** is normally open; **NC** is normally closed.

When the **Val** (value) is **OFF**, the relay is not in an alarm condition. When the **Val** (value) is **ON**, the relay is in an alarm condition. The relay connections for the low indoor temperature alarm are on the LC6000 terminal block; see Table 8 on page 36 for terminal block index.

FIGURE 15
Adjust Alarm Remote Notification
Relay Output Direction

Channel	Dir	Val
7 HumAl	NO	OFF
8 HiTemp	NO	OFF
9 LoTemp	NO	OFF
10 Z1Alm	NO	ON
11 Z2Alm	NO	OFF
12 Z3Alm	NO	OFF

High Temperature Alarm

If the highest temperature sensor value in a zone is above the high temperature setpoint, an alarm will be generated for that zone.

There are two high temperature alarm setpoints. This is the first and there is no remote notification for this alarm.

NOTE: This alarm is per zone. If each zone is meant to operate within the same alarm parameters, each zone will need to be set accordingly.

To adjust the high temperature alarm setpoint:

1. Press MENU key to go to the Main Menu screen.

2. Use UP or DOWN keys and ENTER key to enter USER password 2000.
3. Press UP or DOWN keys to scroll to **Sys Config**; press ENTER key.
4. Press UP or DOWN keys to scroll to **Zone 1, Zone 2** or **Zone 3**; press ENTER key.
5. Press UP or DOWN keys to scroll to **Alarm Setpoints A2-9** (Zone 1), **Alarm Setpoints A3-9** (Zone 2) or **Alarm Setpoints A4-9** (Zone 3).
6. Press ENTER key to scroll to the variable labeled **High Temp** (see Figure 14).
7. Press UP or DOWN keys to adjust setpoint.

High Temperature 2 Alarm

If the highest temperature sensor value in a zone is above the high temperature 2 setpoint, an alarm will be generated for that zone. When this alarm is present, the units will emergency cool in this zone (see unit service manual for information on emergency cooling). Additionally, a relay output will be actuated from the LC to provide remote notification of the event.

NOTE: *This alarm is per zone. If each zone is meant to operate within the same alarm parameters, each zone will need to be set accordingly.*

To adjust the high temperature 2 alarm setpoint:

1. Press MENU key to go to the Main Menu screen.
2. Use UP or DOWN keys and ENTER key to enter USER password 2000.
3. Press UP or DOWN keys to scroll to **Sys Config**; press ENTER key.
4. Press UP or DOWN keys to scroll to **Zone 1, Zone 2** or **Zone 3**; press ENTER key.
5. Press UP or DOWN keys to scroll to **Alarm Setpoints A2-9** (Zone 1), **Alarm Setpoints A3-9** (Zone 2) or **Alarm Setpoints A4-9** (Zone 3).
6. Press ENTER key to scroll to the variable labeled **High Temp 2** (see Figure 14).
7. Press UP or DOWN keys to adjust setpoint.

To change the direction of the remote notification relay output:

1. Press MENU key to go to the Main Menu screen.
2. Use UP or DOWN keys and ENTER key to enter USER password 2000.
3. Press UP or DOWN keys to scroll to **IO Config**; press ENTER key.
4. Press UP or DOWN keys to scroll to **Digital Out Config C3**.
5. Press ENTER key to scroll to the variable in the table that intersects **HiTemp** and **Dir** (see Figure 15).
6. Press UP or DOWN key to change direction.

When the **Val** (value) is **OFF**, the relay is not in an alarm condition. When the **Val** (value) is **ON**, the relay is in an alarm condition. The relay connections for the high indoor temperature 2 alarm are on the LC6000 terminal block; see Table 8 on page 36 for terminal block index.

Emergency Off Alarm Operation

The LC6000 has the capability of shutting down all unit functions in any or all zones from one input. A smoke detector or other device can be used to accomplish this. Terminals 6 and 7 are the terminal block connection points for this device. This input can be configured to accept either normally open or normally closed contacts. These are the contact positions when an event has occurred.

The LC6000 is defaulted to normally open and shipped with a jumper between terminals 6 and 7. This jumper is to be removed when a device is added.

The emergency off function can be enabled or disabled by zone. Resetting the control after an activation is also configurable by zone. Reset can be configured as “auto” meaning once the device contacts revert back to a safe state the units will be functional. Configuring as “user” will require a site visit to manually clear the alarm by holding the alarm icon for 3 seconds.

Additionally there is a relay output that can be monitored remotely to provide notification of an event. Terminals 38 and 39 of the terminal block are for this option. The direction of these contacts can be changed from default of normally open to normally closed.

NOTE: *See Table 8 on page 36 for terminal block index.*

If an emergency off alarm is activated, the LC6000 status message will be “on” or other applicable status. The alarm icon will be red and can be pushed to identify the alarm: #71 Zone 1 emergency off, #72 Zone 2 emergency off, #73 Zone 3 emergency off.

To change the direction of the emergency off input:

1. Press MENU key to go to the Main Menu screen.
2. Use UP or DOWN keys and ENTER key to enter USER password 2000.
3. Press UP or DOWN keys to scroll to **IO Config**; press ENTER key.
4. Press UP or DOWN keys to scroll to **Digital In Config C1**.
5. Press ENTER key to scroll to the variable in the table that intersects **EM Off** and **Dir** (see Figure 16 on page 18).
6. Press UP or DOWN key to change direction.

Emergency Off (EM Off) **Dir** (direction) is the position of the emergency off input contacts during an event. **NO** is normally open; **NC** is normally closed.

EM Off **En** (enable) allows the LC controller to monitor the emergency off input when set to **ON**. When set to **OFF**, the LC controller ignores the emergency off input.

EM Off **Val** (value) of **ON** indicates an event. A **Val** (value) of **OFF** indicates no event.

Emergency off input connections are on the LC6000 terminal block; see Table 8 on page 36 for terminal block index.

FIGURE 16
Adjust Emergency Off, Emergency Vent or Generator Alarm Input Direction

Channel	Dir	En	Val
1 EM Off	NO	OFF	OFF
2 EM Vent	NO	OFF	OFF
3 Gen	NO	OFF	OFF
4 Theft	NO	OFF	OFF

Zone Emergency Off Enable/Disable

Enable and disable emergency off in each zone.

NOTE: Emergency off will shut down all unit functionality. The status will indicate emergency off which will take precedence over all calls.

The LC controller is capable of enabling and disabling emergency off per zone. When the zone is enabled for emergency off, all units in that zone will shut down when this signal is activated.

Another option is to set the alarm reset to **User** or **Auto**. With the **User** option, the alarm will reset once the operator holds down the alarm button for 3 seconds. **Auto** option resets alarm once the contacts change state.

To enable zone emergency off and set the alarm reset:

1. Press MENU key to go to the Main Menu screen.
2. Use UP or DOWN keys and ENTER key to enter USER password 2000.
3. Press UP or DOWN keys to scroll to **Sys Config**; press ENTER key.
4. Press UP or DOWN keys to scroll to **Zone 1**, **Zone 2** or **Zone 3**; press ENTER key.
5. Press UP or DOWN keys to scroll to **Emergency Off A2-13** (Zone 1), **Emergency Off A3-13** (Zone 2) or **Emergency Off A4-13** (Zone 3).
6. Press ENTER key once to move the cursor down to the **Enable** variable (**Yes** or **No**) (see Figure 17).

7. Press the UP or DOWN key to toggle between **Yes** or **No**.
8. Press ENTER key to scroll to the **Reset** variable (**User** or **Auto**).
9. Press the UP or DOWN key to toggle between **User** and **Auto**; press ENTER key.

FIGURE 17
Enable Zone Emergency Off/Set Alarm Reset

Emergency Off	A2-13
Zone 1	
Emergency Off Config	
Enable:	Yes
Reset:	User

To change the direction of the remote notification relay output:

1. Press MENU key to go to the Main Menu screen.
2. Use UP or DOWN keys and ENTER key to enter USER password 2000.
3. Press UP or DOWN keys to scroll to **IO Config**; press ENTER key.
4. Press UP or DOWN keys to scroll to **Digital Out Config C2**.
5. Press ENTER key to scroll to the variable in the table that intersects **EMG Off** and **Dir** (see Figure 18).
6. Press UP or DOWN key to change direction.

The emergency off alarm notification relay has dry contacts. The **Dir** (direction) is the position of the relay without an event. **NO** is normally open; **NC** is normally closed.

When the **Val** (value) is **ON**, the relay is in an alarm condition. The relay connections (emergency off) are on the LC6000 terminal block; see Table 8 on page 36 for terminal block index.

FIGURE 18
Adjust Alarm Remote Notification Relay Output Direction

Channel	Dir	Val
1 HumZ1	NO	OFF
2 HumZ2	NO	OFF
3 HumZ3	NO	OFF
4 EMG Off	NO	OFF
5 Gen	NO	OFF
6 EMG Vent	NO	OFF

Generator Alarm

If the LC detects a generator running event (through a digital input), an alarm will be generated. Additionally, a relay output will be actuated from the LC to provide remote notification of the event. The end user will be able to configure which units are permitted to run during this event. **Default will be to not allow any units to run.**

The generator alarm input can be configured to accept either normally open or normally closed inputs. The controller is defaulted to normally open and a jumper is placed across the terminals of the input (#10 and #11). When this jumper is removed, the alarm will become active.

To change the direction of the generator input:

1. Press MENU key to go to the Main Menu screen.
2. Use UP or DOWN keys and ENTER key to enter USER password 2000.
3. Press UP or DOWN keys to scroll to **IO Config**; press ENTER key.
4. Press UP or DOWN keys to scroll to **Digital In Config C1**.
5. Press ENTER key to scroll to the variable in the table that intersects **Gen** and **Dir** (see Figure 16).
6. Press UP or DOWN key to change direction.

Gen **Dir** (direction) is the position of the generator input contacts in the event of a need for generator operation. **NO** is normally open; **NC** is normally closed.

Gen **En** (enable) allows the LC controller to monitor the generator input contacts when set to **ON**. When set to **OFF**, the LC controller ignores the generator input contacts.

Gen **Val** (value) of **ON** indicates the generator is in operation. A **Val** (value) of **OFF** indicates the generator is not operating.

Generator connections (generator run input) are on the LC6000 terminal block; see Table 8 on page 36 for terminal block index.

While the generator is running, the system will only allow selected units to run. This selection is customizable by the end user. This limitation is in place to match the unit power requirements to the shelter generator capacity.

The default is to not allow any units to run during a generator event. This can be adjusted to allow specific units to run during a generator event.

To change which units run when the generator run input is active:

1. Press MENU key to go to the Main Menu screen.
2. Use UP or DOWN keys and ENTER key to enter TECHNICIAN password 1313.

3. Press UP or DOWN keys to scroll to **Adv System Config**; press ENTER key.
4. Press UP or DOWN keys to scroll to **Generator Disable B13**. This screen displays units 1-6 (as applicable).
5. Press ENTER key to scroll to **01** (see Figure 19).
6. Press UP or DOWN key to change **Disable** to **Enable**.
7. Press ENTER key to save the value and move cursor to **04**.
8. Press UP or DOWN keys and ENTER key to change units to **Enable** as needed.
9. Press ENTER key to scroll back to top line.

The **Generator Disable B13** screen displays units 1-6. To enable/disable units 7-14, press UP or DOWN keys to scroll to **Generator Disable B14** and follow the directions provided above.

FIGURE 19
Adjust Units Running When Generator Is Active

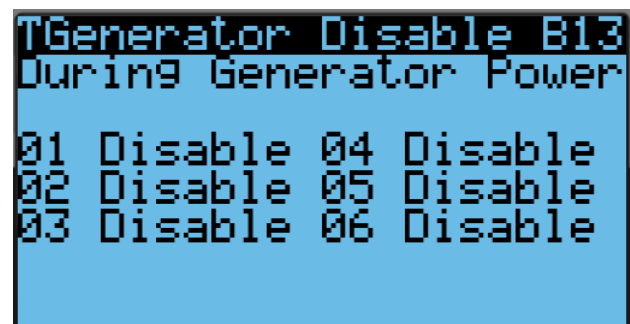

To change the direction of the remote notification relay output:

1. Press MENU key to go to the Main Menu screen.
2. Use UP or DOWN keys and ENTER key to enter USER password 2000.
3. Press UP or DOWN keys to scroll to **IO Config**; press ENTER key.
4. Press UP or DOWN keys to scroll to **Digital Out Config C2**.
5. Press ENTER key to scroll to the variable in the table that intersects **Gen** and **Dir** (see Figure 18).
6. Press UP or DOWN key to change direction.

The generator alarm notification relay has dry contacts. The **Dir** (direction) is the position of the relay without generator operation. **NO** is normally open; **NC** is normally closed.

When the **Val** (value) is **ON**, the relay is in an alarm condition. The relay connections (generator alarm) are on the LC6000 terminal block; see Table 8 on page 36 for terminal block index.

Emergency Vent Alarm Operation

The LC6000 has the capability of signaling the units to ventilate a zone or zones when activated by a hydrogen detector or similar device.

An alarm relay is also activated for remote notification. The ventilation input and the remote notification alarm output are both configurable as normally closed (factory default) or normally open.

When a signal for emergency ventilation is activated, the units with economizers will open dampers 100% and the blowers will run at the highest available speed. Units without economizers will bring on the blowers at the highest available speed. FUSION-TEC WR units have a 45-second blower on delay when emergency ventilation is activated; this is a function of the unit.

Emergency ventilation is overridden by emergency off. Emergency ventilation disables emergency cooling, economizer cooling, compressor cooling, heating and dehumidification. Emergency vent will not operate units that have been disabled during generator run.

When an emergency ventilation event occurs, the LC6000 will have a status of “emer. vent.”. The alarm key will be flashing red; when pushed, the alarm will be identified by zone as “ emergency vent input active”.

Once the input has cleared the units will return to normal operation. The alarm key can be cleared by pushing and holding for 3 seconds; this must be done for each zone.

To wire the device input and remote notification output, refer to Table 8 (LC6000-200 Terminal Block Index) on page 36.

To change the direction of the emergency vent input:

1. Press MENU key to go to the Main Menu screen.
2. Use UP or DOWN keys and ENTER key to enter USER password 2000.
3. Press UP or DOWN keys to scroll to **IO Config**; press ENTER key.
4. Press UP or DOWN keys to scroll to **Digital In Config C1**.
5. Press ENTER key to scroll to the variable in the table that intersects **EM Vent** and **Dir** (see Figure 16 on page 18).
6. Press UP or DOWN key to change direction.

Emergency Vent (EM Vent) **Dir** (direction) is the position of the emergency vent contacts in the event of hydrogen being sensed. **NO** is normally open; **NC** is normally closed.

EM Vent **En** (enable) allows the LC controller to monitor the hydrogen detector when set to **ON**. When set to **OFF**, the LC controller ignores the hydrogen detector.

EM Vent **Val** (value) of **ON** indicates a hydrogen event. A **Val** (value) of **OFF** indicates no hydrogen event.

Emergency vent connections (hydrogen detector input) are on the LC6000 terminal block; see Table 8 on page 36 for terminal block index.

Zone Emergency Vent Enable/Disable

Enable and disable emergency ventilation in each zone.

The LC controller is capable of enabling and disabling emergency ventilation per zone. When the zone is enabled for emergency ventilation, all units with economizers in that zone will ventilate when this signal is activated.

To enable zone emergency ventilation:

1. Press MENU key to go to the Main Menu screen.
2. Use UP or DOWN keys and ENTER key to enter USER password 2000.
3. Press UP or DOWN keys to scroll to **Sys Config**; press ENTER key.
4. Press UP or DOWN keys to scroll to **Zone 1, Zone 2** or **Zone 3**; press ENTER key.
5. Press UP or DOWN keys to scroll to **Emergency Vent A2-14** (Zone 1), **Emergency Vent A3-14** (Zone 2) or **Emergency Vent A4-14** (Zone 3).
6. Press ENTER key once to move the cursor down to the **Enable** variable (**Yes** or **No**) (see Figure 20).
7. Press the UP or DOWN key to toggle between **Yes** or **No**.

FIGURE 20
Enable Zone Emergency Ventilation

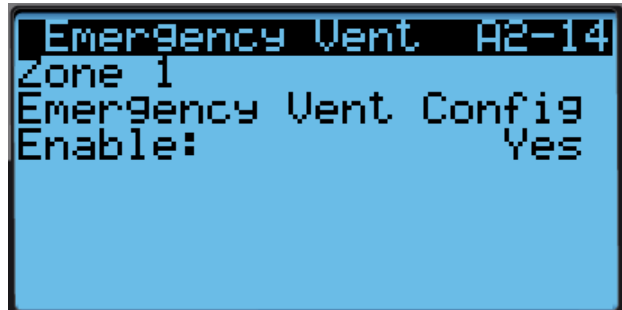

To change the direction of the remote notification relay output:

1. Press MENU key to go to the Main Menu screen.
2. Use UP or DOWN keys and ENTER key to enter USER password 2000.
3. Press UP or DOWN keys to scroll to **IO Config**; press ENTER key.
4. Press UP or DOWN keys to scroll to **Digital Out Config C2**.
5. Press ENTER key to scroll to the variable in the table that intersects **EMG Vent** and **Dir** (see Figure 18 on page 18).

- Press UP or DOWN key to change direction.

The emergency vent alarm notification relay has dry contacts. The **Dir** (direction) is the position of the relay without a hydrogen event. **NO** is normally open; **NC** is normally closed.

When the **Val** (value) is **ON**, the relay is in an alarm condition. The relay connections (emergency vent alarm) are on the LC6000 terminal block; see Table 8 on page 36 for terminal block index.

Zone Unit Alarm

By default, if any of the units communicate a high pressure or low pressure alarm to the LC, the LC will actuate a relay output to provide remote notification of the event. A relay output will be actuated from the LC to provide remote notification of the event for each zone.

To change the direction of the remote notification relay output:

- Press MENU key to go to the Main Menu screen.
- Use UP or DOWN keys and ENTER key to enter USER password 2000.
- Press UP or DOWN keys to scroll to **IO Config**; press ENTER key.
- Press UP or DOWN keys to scroll to **Digital Out Config C3**.
- Press ENTER key to scroll to the variable in the table that intersects **Z1Alm** and **Dir**, **Z2Alm** and **Dir**, or **Z3Alm** and **Dir** (see Figure 15 on page 16).
- Press UP or DOWN key to change direction.

When the direction is set to NO, the relay output will be closed when the alarm is active and open when not active. When the direction is set to NC, the relay output will be open when alarm is active and closed when not active.

The zone alarms can be configured to actuate based on 15 alarms communicated from each wall unit. These items can be selected for each zone.

To select which wall unit alarms actuate zone alarms:

- Press MENU key to go to the Main Menu screen.
- Use UP or DOWN keys and ENTER key to enter TECHNICIAN password 1313.
- Press UP or DOWN keys to scroll to **Adv Sys Config**; press ENTER key.
- Press UP or DOWN keys to scroll to **Zone Alarm Config B4**, **Zone Alarm Config B5** and **Zone Alarm Config B6**. The 15 alarms are divided between these three screens.
- Press ENTER key to scroll to the variable in the table that intersects with each alarm and zone number (see Figure 21).

- Press UP or DOWN key to change value (N or Y).
If a value of Y is entered, the wall unit alarm will trigger the zone alarm relay output. If a value of N is entered, the wall unit alarm will not trigger the zone alarm relay output.

NOTE: By default, only 'no temperature sensors' and high and low pressure actuate the alarms.

NOTE: Power Loss group is also affected by communication loss.

NOTE: If no temperature sensors are detected by the controller for a given zone, that zone alarm output will be actuated. This is nonconfigurable.

FIGURE 21
Adjust Zone Alarm Configuration

TZone Alarm Config B4			
Alarm types that will cause zone alarms			
	Z1	Z2	Z3
Blower	N	N	N
Dirty Cond.	N	N	N
Dust	N	N	N
Economizer	N	N	N

TZone Alarm Config B5			
	Z1	Z2	Z3
EEU	N	N	N
Dirty Filter	N	N	N
Freeze	N	N	N
High Press.	Y	Y	Y
Low Press.	Y	Y	Y
Memory	N	N	N

TZone Alarm Config B6			
	Z1	Z2	Z3
Return Air	N	N	N
Sens. Fail.	N	N	N
Supply Air	N	N	N
th_Tune	N	N	N
Power Loss	N	N	N

Humidity Alarm

When the LC detects a high indoor humidity or low indoor humidity event in a selected zone (through an analog input from a remote sensor), an alarm will be generated. Additionally, a relay output will be actuated from the LC to provide remote notification of the event. The end user can configure the alarm to be actuated when the measurement is high, low or both high and low.

To adjust the humidity alarm setpoints:

1. Press MENU key to go to the Main Menu screen.
2. Use UP or DOWN keys and ENTER key to enter USER password 2000.
3. Press UP or DOWN keys to scroll to **Sys Config**; press ENTER key.
4. Press UP or DOWN keys to scroll to **Zone 1, Zone 2 or Zone 3**; press ENTER key.
5. Press UP or DOWN keys to scroll to **Alarm Setpoints A2-10** (Zone 1), **Alarm Setpoints A3-10** (Zone 2) or **Alarm Setpoints A4-10** (Zone 3).
6. Press ENTER key to scroll to **Low Humidity**, **High Humidity** or **Alarm Delay** (delay in seconds from the time the alarm is sensed until the alarm is displayed). See Figure 22.
7. Press UP and DOWN keys to adjust setpoints or delay.

FIGURE 22
Adjust Humidity Alarm Setpoints

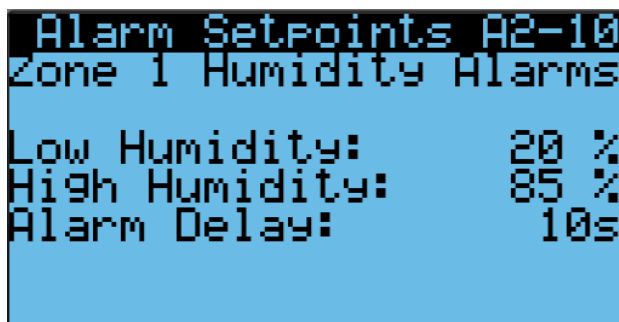

To adjust the direction of the remote notification relay output:

1. Press MENU key to go to the Main Menu screen.
2. Use UP or DOWN keys and ENTER key to enter USER password 2000.
3. Press UP or DOWN keys to scroll to **IO Config**; press ENTER key.
4. Press UP or DOWN keys to scroll to **Digital Out Config C3**.
5. Press ENTER key to scroll to the variable in the table that intersects **HumAl** and **Dir** (see Figure 15).
6. Press UP or DOWN key to change direction.

When the direction is set to NO, the relay output will be closed when alarm is active and open when not active. When the direction is set to NC, the relay output will be open when alarm is active and closed when not active.

Alarm Grouping

The LC6000 is equipped with relay outputs to indicate the alarm statuses of the system. The alarms are separated into three groups. Each group shares a common on the programmable controller. Extra terminal blocks are provided for each output but they are jumpered together. Because of this, care should be taken to ensure the systems connected to these terminals correctly read the state of the relays. The inputs of the remote monitoring system should be connected to the even terminals of the LC6000. See Figures 23-25 for alarm grouping options.

NOTE: See pages 36-38 to reference LC6000 terminal lists and wiring diagram.

Relay output rated at 230V 1A.

FIGURE 23
Option 1: Inputs Referencing Voltage

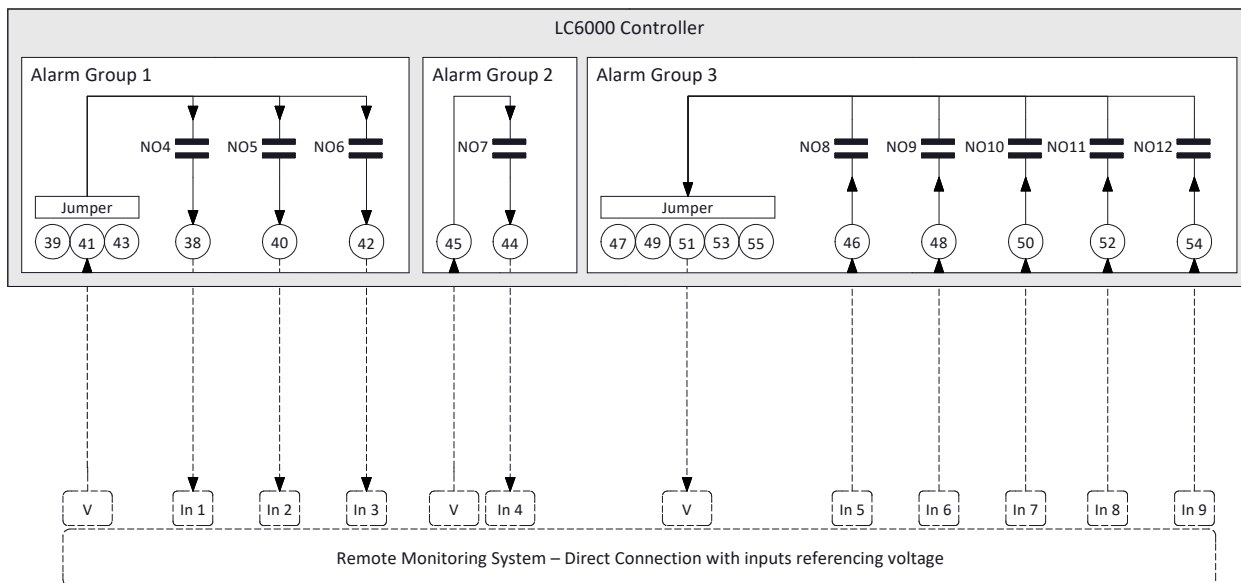

MIS-4441

FIGURE 24
Option 2: Inputs Referencing Ground

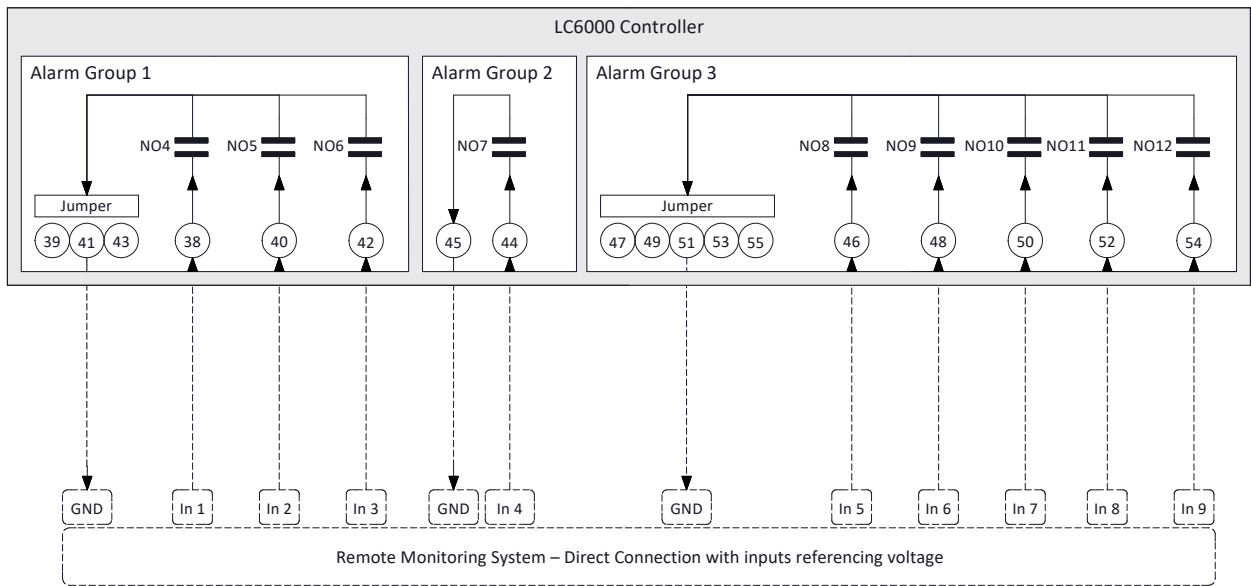

MIS-4442

FIGURE 25
Option 3: Isolation Relays

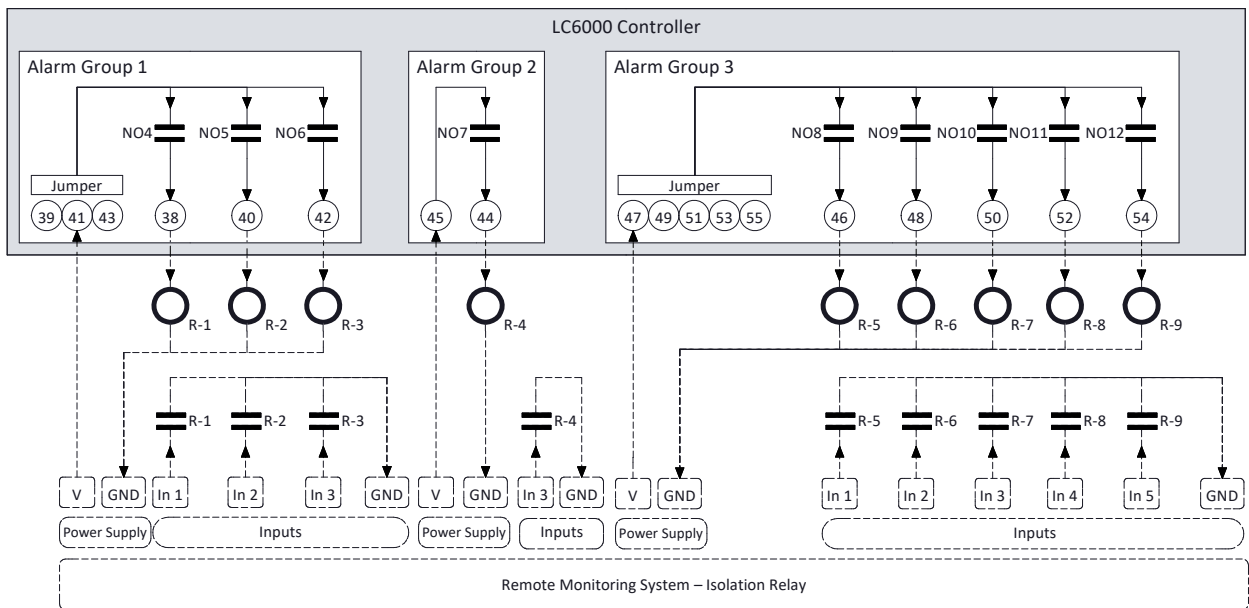

MIS-4443

CONTROL OPERATION

NOTE: Screenshots shown in this manual reflect default settings (when applicable).

Temperature Control

Setpoint Adjustment

Cooling and heating setpoints can be adjusted by navigating to setpoint adjustment screen A2-1, A3-1, or A4-1 (see Figure 26). These screens can be accessed by pressing the MENU key and entering user password 2000. The cooling setpoint default is 77°F and can be set between 8° above the heating setpoint and up to 95°F. The heating setpoint default value is 60°F and can be set between 8° below the cooling setpoint and 32°F. The 8° of separation only applies when dehumidification is enabled in a zone. When dehumidification is not enabled, the setpoints can be set as close as 2° apart.

FIGURE 26
Cooling and Heating Setpoints

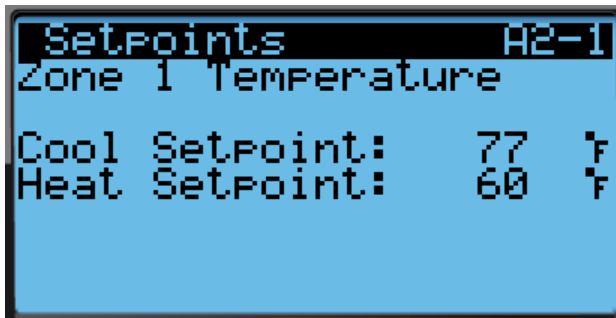

Indoor Temperature Averaging

The LC has the ability to average all of the zone temperature sensors connected to the LC and the return air temperature sensors connected to the wall-mount unit, use only the zone temperature sensors, or use the LC sensors and any unit which has its blower run continuously. This can be set differently for each zone. This value will then be used as a **zone indoor temperature** for the LC and wall-mount unit control functions.

There are three possible sensor averaging selections:

- **LC Only**
This configuration only averages the zone temperature sensors connected to the LC and enabled within the specific zone.
- **Blower On**
This configuration averages any temperature sensors connected to the LC that are enabled and the return air temperature sensor of any wall-mount unit set to run in continuous blower within the specific zone.

- **All Sensors**
This configuration averages the zone temperature sensors connected to the LC that are enabled and all the return air temperature sensors of all wall-mount units within the specific zone, regardless of blower operation.

To change the indoor temperature averaging type:

1. Press MENU key to go to the Main Menu screen.
2. Use UP or DOWN keys and ENTER key to enter USER password 2000.
3. Press UP or DOWN keys to scroll to **Sys Config**; press ENTER key.
4. Press UP or DOWN keys to scroll to **Zone 1, Zone 2** or **Zone 3**; press ENTER key.
5. Press UP or DOWN keys to scroll to **Zone Temp A2-11** (Zone 1), **Zone Temp A3-11** (Zone 2) or **Zone Temp A4-11** (Zone 3).
6. Press ENTER key to scroll to **Selection** (see Figure 27).
7. Press UP and DOWN keys to adjust.

FIGURE 27
Change Indoor Temperature Averaging Type

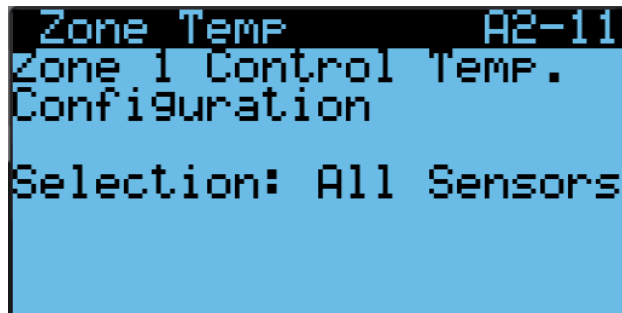

Comfort Mode

If comfort mode is activated, all of the zone setpoints will be set to 72°F for cooling and 70°F (comfort setpoint -2) for heating. This setpoint will be active for 60 minutes.

To enable comfort mode:

1. Press UP or DOWN key while on the Status screen to select **Setpoints** (Set) from the Quick Menu options; press ENTER key.
2. Press ENTER key to scroll to **Comfort Mode**.
3. Press UP or DOWN keys to change the duration of comfort mode.
4. Press ENTER key to scroll to **Comfort Setpoint**.
5. Press UP and DOWN keys to change the cooling setpoint for comfort mode.

6. Press ENTER key to scroll to **Comfort Enable**.
7. Press UP or DOWN key to change value from OFF to ON; press ENTER key.

The system is now in comfort mode and will cool or heat to the comfort setpoint for the 60-minute duration.

Staging

The LC6000 will stage all of the equipment up and down to control temperature and humidity. The staging settings will be applied to freecooling, cooling, heating and dehumidification. The manner in which the equipment is staged is determined by the staging order setting and the staging type setting. The following descriptions use the worst case scenario of three stages per unit and the complexity will be reduced if equipment only has one stage available.

Staging Order

This setting will determine the order in which the units are turned on and off.

Staging order settings: FIFO (see Table 2), LIFO (see Table 3 on page 26) and Demand (see Tables 3 and 4 on pages 26 and 27).

Staging Type

Alternating

The first stage of each unit will be engaged according to the staging order. Once all units have stage 1 engaged, the second stage of each unit will be engaged

according to the staging order. Once all available units have stage 2 engaged, the third stage of each unit will be engaged according to the staging order. The third stage of each unit will be disengaged according to the staging order. Once all available units have stage 3 disengaged, the second stage of each unit will be staged down according to the staging order. Once all available units have stage 2 disengaged, the first stage of each unit will be staged down according to the staging order.

NOTE: *Units with more staging capability will be turned off before units with lower staging capability even if staging order indicates they should be the next off. And units with fewer stages active will be staged up before units with stages active.*

Non-Alternating

The first unit in the staging order will be staged up fully before moving to the next unit in the staging order. This will continue until the last unit is staged up fully or demand decreases. When the demand decreases, the first unit to turn off based on the staging order will stage down fully before moving to the next unit. This will continue until the last unit is staged down or demand begins to increase again.

Simultaneous

All units in the zone will be staged up together acting as one system using the maximum number of stages detected in the zone.

TABLE 2
FIFO: First In First Out

The first unit staged on will be the first unit staged off

Stage	Alternating Stage Up			Non-Alternating Stage Up			Alternating Stage Down			Non-Alternating Stage Down		
	1	2	3	1	2	3	1	2	3	1	2	3
Unit 1	1	15	29	1	2	3	29	15	1	3	2	1
Unit 2	2	16	30	4	5	6	30	16	2	6	5	4
Unit 3	3	17	31	7	8	9	31	17	3	9	8	7
Unit 4	4	18	32	10	11	12	32	18	4	12	11	10
Unit 5	5	19	33	13	14	15	33	19	5	15	14	13
Unit 6	6	20	34	16	17	18	34	20	6	18	17	16
Unit 7	7	21	35	19	20	21	35	21	7	21	20	19
Unit 8	8	22	36	22	23	24	36	22	8	24	23	22
Unit 9	9	23	37	25	26	27	37	23	9	27	26	25
Unit 10	10	24	38	28	29	30	38	24	10	30	29	28
Unit 11	11	25	39	31	32	33	39	25	11	33	32	31
Unit 12	12	26	40	34	35	36	40	26	12	36	35	34
Unit 13	13	27	41	37	38	39	41	27	13	39	38	37
Unit 14	14	28	42	40	41	42	42	28	14	42	41	40

TABLE 3
LIFO: Last In First Out

The last unit staged on will be the first unit staged off

Stage	Alternating Stage Up			Non-Alternating Stage Up			Alternating Stage Down			Non-Alternating Stage Down		
	1	2	3	1	2	3	1	2	3	1	2	3
Unit 1	1	15	29	1	2	3	42	28	14	42	41	40
Unit 2	2	16	30	4	5	6	41	27	13	39	38	37
Unit 3	3	17	31	7	8	9	40	26	12	36	35	34
Unit 4	4	18	32	10	11	12	39	25	11	33	32	31
Unit 5	5	19	33	13	14	15	38	24	10	30	29	28
Unit 6	6	20	34	16	17	18	37	23	9	27	26	25
Unit 7	7	21	35	19	20	21	36	22	8	24	23	22
Unit 8	8	22	36	22	23	24	35	21	7	21	20	19
Unit 9	9	23	37	25	26	27	34	20	6	18	17	16
Unit 10	10	24	38	28	29	30	33	19	5	15	14	13
Unit 11	11	25	39	31	32	33	32	18	4	12	11	10
Unit 12	12	26	40	34	35	36	31	17	3	9	8	7
Unit 13	13	27	41	37	38	39	30	16	2	6	5	4
Unit 14	14	28	42	40	41	42	29	15	1	3	2	1

TABLE 4
Demand: Return Air Demand Cooling

In cooling operations, the unit with the warmest return air temperature will be the first unit turned on and the unit with the coolest return air will be the first one turned off.

NOTE: Unit order is random to demonstrate return air differences. This list will dynamically change as the temperature in the space changes. Warmest unit is first on the list, coolest is last.

Stage	Alternating Stage Up			Non-Alternating Stage Up			Alternating Stage Down			Non-Alternating Stage Down		
	1	2	3	1	2	3	1	2	3	1	2	3
Unit 10	1	15	29	1	2	3	42	28	14	42	41	40
Unit 12	2	16	30	4	5	6	41	27	13	39	38	37
Unit 13	3	17	31	7	8	9	40	26	12	36	35	34
Unit 4	4	18	32	10	11	12	39	25	11	33	32	31
Unit 5	5	19	33	13	14	15	38	24	10	30	29	28
Unit 7	6	20	34	16	17	18	37	23	9	27	26	25
Unit 14	7	21	35	19	20	21	36	22	8	24	23	22
Unit 8	8	22	36	22	23	24	35	21	7	21	20	19
Unit 9	9	23	37	25	26	27	34	20	6	18	17	16
Unit 6	10	24	38	28	29	30	33	19	5	15	14	13
Unit 11	11	25	39	31	32	33	32	18	4	12	11	10
Unit 2	12	26	40	34	35	36	31	17	3	9	8	7
Unit 3	13	27	41	37	38	39	30	16	2	6	5	4
Unit 1	14	28	42	40	41	42	29	15	1	3	2	1

TABLE 5
Demand: Return Air Demand Heating

In cooling operations, the unit with the warmest return air temperature will be the first unit turned on and the unit with the coolest return air will be the first one turned off.

<i>NOTE: Unit order is random to demonstrate return air differences. This list will dynamically change as the temperature in the space changes. Warmest unit is first on the list, coolest is last.</i>												
	Alternating Stage Up			Non-Alternating Stage Up			Alternating Stage Down			Non-Alternating Stage Down		
Stage	1	2	3	1	2	3	1	2	3	1	2	3
Unit 10	14	28	42	40	41	42	1	15	29	3	2	1
Unit 12	13	27	41	37	38	39	2	16	30	6	5	4
Unit 13	12	26	40	34	35	36	3	17	31	9	8	7
Unit 4	11	25	39	31	32	33	4	18	32	12	11	10
Unit 5	10	24	38	28	29	30	5	19	33	15	14	13
Unit 7	9	23	37	25	26	27	6	20	34	18	17	16
Unit 14	8	22	36	22	23	24	7	21	35	21	20	19
Unit 8	7	21	35	19	20	21	8	22	36	24	23	22
Unit 9	6	20	34	16	17	18	9	23	37	27	26	25
Unit 6	5	19	33	13	14	15	10	24	38	30	29	28
Unit 11	4	18	32	10	11	12	11	25	39	33	32	31
Unit 2	3	17	31	7	8	9	12	26	40	36	35	34
Unit 3	2	16	30	4	5	6	13	27	41	39	38	37
Unit 1	1	15	29	1	2	3	14	28	42	42	41	40

To change the staging type or order:

1. Press MENU key to go to the Main Menu screen.
2. Use UP or DOWN keys and ENTER key to enter USER password 2000.
3. Press UP or DOWN keys to scroll to **Sys Config**; press ENTER key.
4. Press UP or DOWN keys to scroll to **Zone 1, Zone 2** or **Zone 3**; press ENTER key.
5. Press UP or DOWN keys to scroll to **Staging A2-5** (Zone 1), **A3-5** (Zone 2) or **A4-5** (Zone 3).
6. Press ENTER key to scroll to the variable labeled **Type** (see Figure 28).

7. Press UP or DOWN keys to adjust.
8. Press ENTER key to scroll to the variable labeled **Order**.
9. Press UP or DOWN keys to adjust.

Staging Delay

A delay on and off can be set for economizer (FC), cooling (CL) and heating (HT) independently for each zone. This will limit how fast the units can be staged on or off.

To adjust the on and off delay times:

1. Press MENU key to go to the Main Menu screen.
2. Use UP or DOWN keys and ENTER key to enter USER password 2000.
3. Press UP or DOWN keys to scroll to **Sys Config**; press ENTER key.
4. Press UP or DOWN keys to scroll to **Zone 1, Zone 2** or **Zone 3**; press ENTER key.
5. Press UP or DOWN keys to scroll to **Staging A2-5** (Zone 1), **Staging A3-5** (Zone 2) or **Staging A4-5** (Zone 3).
6. Press ENTER key to scroll to the variable in the table that intersects **FC, CL** or **HT** and **Delay On** or **Delay Off** (see Figure 28).
7. Press UP or DOWN keys to adjust.

FIGURE 28
Adjust Staging Type or Order

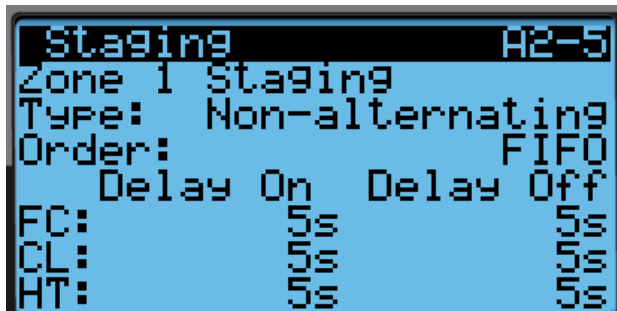

Maximum Number of Units Running

The maximum number of units that will be staged on can be configured for each zone. The number is defaulted at the total number of units capable so that they are fully utilized by default. This is configurable for economizer, cooling and heating independently.

To adjust the maximum number of units running:

1. Press MENU key to go to the Main Menu screen.
2. Use UP or DOWN keys and ENTER key to enter USER password 2000.
3. Press UP or DOWN keys to scroll to **Sys Config**; press ENTER key.
4. Press UP or DOWN keys to scroll to **Zone 1, Zone 2** or **Zone 3**; press ENTER key.
5. Press UP or DOWN keys to scroll to **Staging A2-6** (Zone 1), **Staging A3-6** (Zone 2) or **Staging A4-6** (Zone 3).
6. Press ENTER key to scroll to the variable for **Freecooling, Cooling** or **Heating** (see Figure 29).
7. Press UP or DOWN keys to adjust number of units.

FIGURE 29

Staging Maximum Number of Units Running

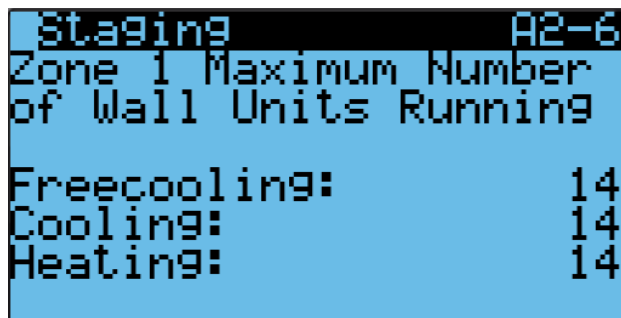

Rotation

The units in each zone can be rotated based on a configurable number of days (1-7); the time is defaulted to 7 days. Rotation of unit occurs in each zone. Lead unit rotation will not rotate a unit from one zone to another. Additionally, there must be two or more units in a zone for rotation to occur.

In addition to time based, a manual rotation can be triggered for troubleshooting.

To change the rotation variables:

1. Press MENU key to go to the Main Menu screen.
2. Use UP or DOWN keys and ENTER key to enter USER password 2000.
3. Press UP or DOWN keys to scroll to **Sys Config**; press ENTER key.
4. Press UP or DOWN keys to scroll to **Zone 1, Zone 2** or **Zone 3**; press ENTER key.

5. Press UP or DOWN keys to scroll to **Rotation A2-7** (Zone 1), **Rotation A3-7** (Zone 2) or **Rotation A4-7** (Zone 3).
6. Press ENTER key to scroll to **Time Based** (see Figure 30). The changeover time is 12 am.
7. Press UP or DOWN key to change ON to OFF.
8. Press ENTER key to scroll to **Num. of Days**.
9. Press UP or DOWN keys to adjust the number of days.
10. Press ENTER key to scroll to **Manual**.
11. Press UP or DOWN key to change OFF to ON.

FIGURE 30
Rotation

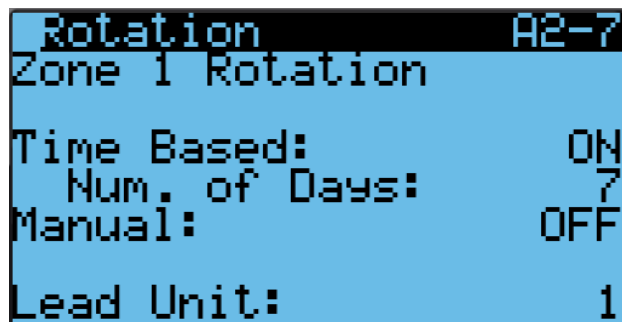

Demand

The system will compare the zone temperature (determined by zone averaging selection) to the zone cooling and heating setpoint. A demand will be calculated to determine how many units are required.

For cooling, the zone temperature will be compared to the cooling setpoint. The controller will calculate a demand based on how far above the setpoint and how long it has been above the setpoint. The demand value (0-100%) will then be split and applied to free cooling and cooling separately shown as two demands both ranged 0-100% applied to all of the available cooling methods for that zone. For example, if the demand is at 50% and there are 10 available stages of cooling in that zone, there would be 5 stages active (50% x 10 = 5). The system will prioritize free cooling stages over compressor stages. Adding to the example, if 5 of the 10 stages for cooling are economizer, 5 units would be running economizer and no compressors running. The demand is calculated for the cooling application. However, for display purposes, the demand is split so that the user can see demand separately for free cooling and compressor.

For heating, the zone temperature will be compared to the heating setpoint. The controller will calculate a demand based on how far below the setpoint and how long it has been below the setpoint. The demand value 0-100% will be applied to all of the available stages

of heating in that zone. For example, if the demand is at 50% and there are 5 available stages of heating in that zone, there would be 2 stages active ($50\% \times 5 = 2.5$ and a half of a stage cannot be turned on).

Humidity Control

The LC can be configured to control up to three humidifiers (field supplied) with relay outputs and up to 14 units equipped with dehumidification. The indoor humidity level for each zone is compared to the dehumidification setpoint and humidification setpoint for each zone.

Staged Dehumidification

The supervisory controller will monitor the indoor relative humidity of each zone and compare the value of the setpoint of each mode. Below are the three modes available for dehumidification of each zone. Unit dehumidification options are determined by model number; all units in a zone must have the same dehumidification options or combined with nondehumidification models. If communication is lost with the supervisory controller during a dehumidification call, dehumidification function will be ended and the unit will operate in orphan mode.

Dehumidification Off

When the humidity level inside a zone falls to the Dehumidification Off setpoint, the system will stop attempting to dehumidify the space. The default setpoint value for this mode is 60% RH.

Passive Dehumidification

When the humidity level rises to the Passive Dehumidification setpoint, the controller will activate staged dehumidification at the available wall units. As the humidity level rises to the passive dehumidification setpoint, the free cooling function (economizer) is disabled. When there is a call for cooling, the compressor will energize and the blower speed will be reduced to the unit dehumidification mode or Balanced Climate speed whichever is applicable to the unit. All units allowed to run within the zone will be given the dehumidification command and will operate as such on a call for cooling. The default setpoint value for passive dehumidification is 70% RH.

Active Dehumidification

When the humidity level rises to the Active Dehumidification setpoint, the supervisory controller will active staged dehumidification at the available wall units. The supervisory controller will then calculate the dehumidification demand based on how far above the setpoint and how long the RH level has been above the setpoint. The controller will then utilize all of the units with active dehumidification capabilities to reduce the indoor humidity level. The units will be staged on based on the existing cooling rotation for the units in the zone up to the maximum number of units allowed to

run. When in demand minimum compressor run time is applicable, examples of demand are as follows:

With two units with dehumidification capabilities, Unit 1 in rotation will come on at 50% demand and Unit 2 in rotation will come on at 100% demand. They will rotate off in a reverse; Unit 2 will be off at 50% demand and Unit 1 will be off at the dehumidification off setpoint.

With three units with dehumidification capabilities, Unit 1 in rotation will come on at 33% demand, Unit 2 in rotation will come on at 67% demand and Unit 3 in rotation will come on at 100% demand. They will rotate off in reverse; Unit 3 will be off at 67% demand, Unit 2 will be off at 33% demand and Unit 1 will be off at dehumidification off setpoint.

An active dehumidification sequence will run until the space temperature falls to the heating setpoint or increases to the cooling setpoint, or the dehumidification off setpoint is reached. Refer to the specific unit manual for active dehumidification sequence and space temperature control.

The passive dehumidification setpoint must be lower than the active dehumidification setpoint to ensure the economizer is disabled during active dehumidification.

Availability for active dehumidification will be determined by model number. Units with electric reheat, mechanical dehumidification or cycling reheat will be considered. The active dehumidification default setpoint is 80% RH.

NOTE: Only one type of dehumidification unit per zone will be considered depending upon configuration of the LC6000 controller. Unit capability is determined by the model number.

To change the dehumidification setpoints:

1. Press MENU key to go to the Main Menu screen.
2. Use UP or DOWN keys and ENTER key to enter USER password 2000.
3. Press UP or DOWN keys to scroll to **Sys Config**; press ENTER key.
4. Press UP or DOWN keys to scroll to **Zone 1, Zone 2** or **Zone 3**; press ENTER key.
5. Press UP or DOWN keys to scroll to **Setpoints A2-2** (Zone 1), **Setpoints A3-2** (Zone 2) or **Setpoints A4-2** (Zone 3).
6. Press ENTER key to scroll to **Dehumidification Off, Passive On** or **Active On** (see Figure 31 on page 30).
7. Press UP and DOWN keys to change dehumidification setpoints to desired values.

FIGURE 31
Humidity Control Setpoints

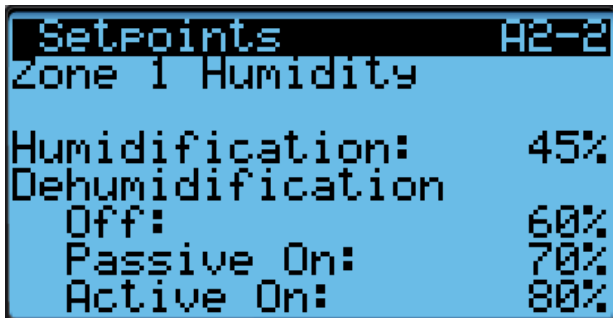

In addition to the setpoint configuration for dehumidification, each zone must be configured for the type of active dehumidification.

To change the dehumidification type:

1. Press MENU key to go to the Main Menu screen.
2. Use UP or DOWN keys and ENTER key to enter USER password 2000.
3. Press UP or DOWN keys to scroll to **Sys Config**; press ENTER key.
4. Press UP or DOWN keys to scroll to **Zone 1, Zone 2** or **Zone 3**; press ENTER key.
5. Press UP or DOWN keys to scroll to **Setpoints A2-3** (Zone 1), **Setpoints A3-3** (Zone 2) or **Setpoints A4-3** (Zone 3).
6. Press ENTER key to scroll to **Type** (see Figure 32).
7. Press UP and DOWN keys to change to desired value. Dehumidification type choices are **None**, **Electric Reheat**, **Mechanical Reheat** or **Cycling Reheat**. The units in the zone being configured will need to have the capability of the setting being selected (see unit model number).

FIGURE 32
Dehumidification Types

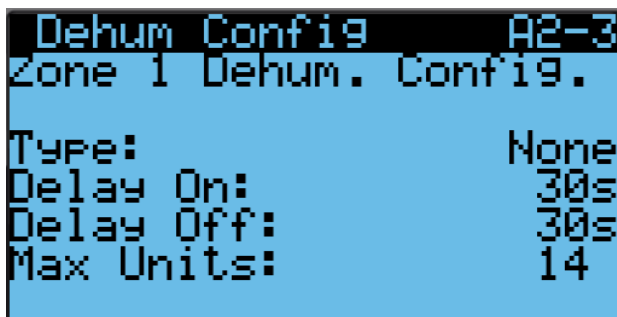

Humidification

If the humidity level is below 45% RH (Humidification Setpoint), the LC will enable humidification for that zone. Once the humidity level rises to 55% RH (humidification setpoint plus 10% RH), the humidification for that zone will be disabled.

NOTE: Humidifiers are field supplied.

To change the humidification setpoint:

1. Press MENU key to go to the Main Menu screen.
2. Use UP or DOWN keys and ENTER key to enter USER password 2000.
3. Press UP or DOWN keys to scroll to **Sys Config**; press ENTER key.
4. Press UP or DOWN keys to scroll to **Zone 1, Zone 2** or **Zone 3**; press ENTER key.
5. Press UP or DOWN keys to scroll to **Setpoints A2-2** (Zone 1), **Setpoints A3-2** (Zone 2) or **Setpoints A4-2** (Zone 3).
6. Press ENTER key to scroll to **Humidification** (see Figure 31).
7. Press UP and DOWN keys to change humidification setpoint to desired value.

Enabling Humidifier

1. Press MENU key to go to the Main Menu screen.
2. Use UP or DOWN keys and ENTER key to enter USER password 2000.
3. Press UP or DOWN keys to scroll to **Sys Config**; press ENTER key.
4. Press UP or DOWN keys to scroll to **General**; press ENTER key.
5. Press ENTER key to scroll to **Humidifiers** (see Figure 33).
6. Press UP or DOWN keys to change value to **NONE**, **Zone 1, Z1 & Z2** or **Z1, Z2, & Z3**.
7. Press ENTER to scroll to **Humidifier Type**.
8. Press UP or DOWN keys to change value to **Relay** from **Comm**.

FIGURE 33
Enabling Humidifier

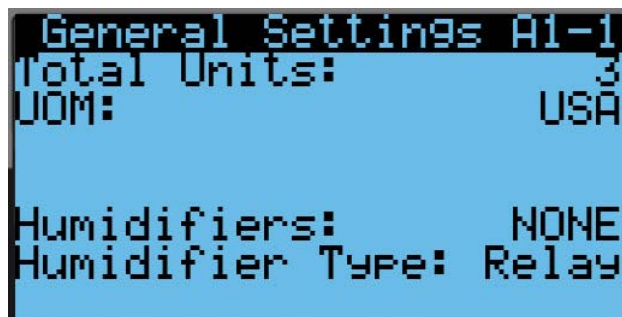

Continuous Blower

The LC will have the option in each zone to operate in continuous blower. The options are None, Lead, All and Custom. When None is selected, continuous blower will be disabled on all units in that zone. When Lead is selected, only the lead unit will have continuous blower activated. When All is selected, continuous blower will be enabled on all units in that zone. When Custom is selected, only units specifically commanded on by the end user will run in that zone.

To change the continuous blower status of each zone:

1. Press MENU key to go to the Main Menu screen.
2. Use UP or DOWN keys and ENTER key to enter USER password 2000.
3. Press UP or DOWN keys to scroll to **Sys Config**; press ENTER key.
4. Press UP or DOWN keys to scroll to **Zone 1, Zone 2** or **Zone 3**; press ENTER key.
5. Press UP or DOWN keys to scroll to **Cont. Blower A2-8** (Zone 1), **Cont. Blower A3-8** (Zone 2) or **Cont. Blower A4-8** (Zone 3).
6. Press ENTER key to scroll to **Selection** (see Figure 34).
7. Press UP and DOWN keys to change to desired choice.

FIGURE 34
Continuous Blower Status

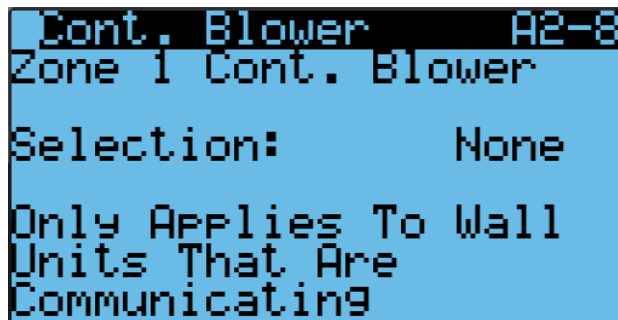

Continuous Blower Custom Configuration

When Custom is selected, only unit specifically commanded on by the end user will run in that zone.

To select the units to run in continuous blower:

1. Press MENU key to go to the Main Menu screen.
2. Use UP or DOWN keys and ENTER key to enter TECHNICIAN password 1313.
3. Press UP or DOWN keys to scroll to **Adv Sys Config**; press ENTER key.
4. Press UP or DOWN keys to scroll to **Cont. Blower Cust. B10, Cont. Blower Cust. B11** or **Cont. Blower Cust. B12**. The wall-mount units are divided between these three screens.
5. Press ENTER key to scroll to the variable in the Enable column that represents the desired wall mount unit (see Figure 35).
6. Press UP or DOWN key to change value from No to Yes (to enable that unit for continuous blower) or Yes to No (to disable that unit for continuous blower).
7. Press ENTER key to save.

FIGURE 35
Continuous Blower Custom Configuration

Unit	Zone	Enable?
1	0	No
2	0	No
3	0	No
4	0	No
5	0	No
6	0	No

Unit	Zone	Enable?
7	0	No
8	0	No
9	0	No
10	0	No
11	0	No
12	0	No

Unit	Zone	Enable?
13	0	No
14	0	No

ADDITIONAL INFORMATION

LC6000 Menus/Screens

Main Menu

Press the MENU key from any screen to return to the Main Menu. Press the UP or DOWN keys to scroll through the available menus. When the desired menu is highlighted, press the ENTER key to access that menu. Press the ESCAPE key or MENU key to return to the Status screen from the Main Menu.

Status Screen

The Status screen is the default start-up screen and also the return screen after 5 minutes of no activity. The screen can be accessed any time by pressing the ESCAPE button repeatedly. The LC6000 Status screen displays the current date, time, unit displayed, zone and system status (see Table 7 for status messages).

Quick Menu

The Quick Menu is available on the Status screen. Use UP or DOWN keys while on the Status screen to scroll between the three Quick Menu options; press ENTER key.

Alarm Log

The alarm log displays the record number, time of alarm event, date of alarm event, description of alarm event and whether the entry is the beginning or end of event. The alarm log will have as many screens as events occurred.

Info

The information menu groups all information by unit address. The LC6000 controller is capable of operating MULTI-TEC, FUSION-TEC WR Series and MEGA-TEC wall-mount units. The screens will automatically show the relevant information for each unit. For example, the FUSION-TEC WR Series and MEGA-TEC wall-mount units are equipped with a supply air temperature sensor while the MULTI-TEC units are not. The supply temperature measurement will only show when displaying information from a FUSION-TEC WR Series or MEGA-TEC wall-mount unit. Additionally, FUSION-TEC WR Series units are equipped with an electronic expansion valve (EEV). When connected to a FUSION-TEC WR Series unit, an additional screen will show pressures and temperatures affecting the air conditioning system. MEGA-TEC wall-mount units are equipped with two electronic expansion valves with additional screens that show pressures and temperatures for each EEV.

The last of the wall-mount unit's information screens will display the model number, serial number and software version of the unit (see Figures 36, 37 and 38). This information is very important and could be needed when referencing technical documentation online or contacting Bard Technical Services.

FIGURE 36
MULTI-TEC Unit Information Screen

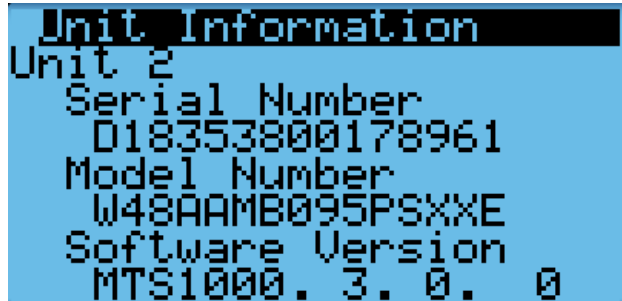

FIGURE 37
FUSION-TEC WR Series Unit Information Screen

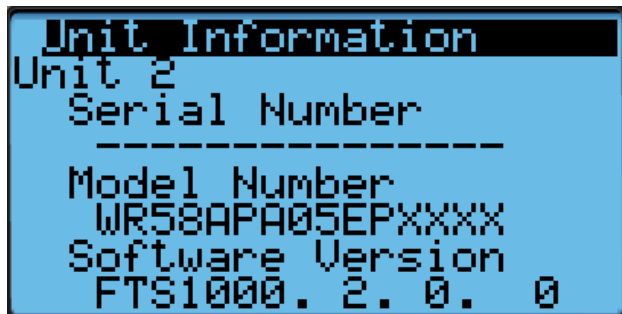
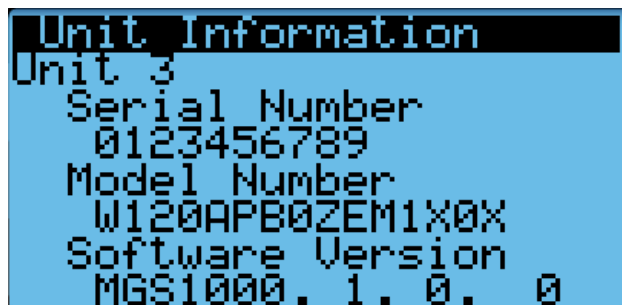

FIGURE 38
MEGA-TEC Unit Information Screen



Software Versioning Guide

LCS6000.X.Y.Z

Software Name: The name of the software is the base part number used to identify which product the software is used in (see Table 6).

- X The letter X represents a major change to the software effecting product compatibility or function of the equipment.
- Y The letter Y represents a minor change to the software that either adds, removes, or alters a feature of the equipment without effecting compatibility with other products.

- Z The letter Z represents a change to the software that fixes existing features or user interface.

TABLE 6
Software Versioning Guide

Product	Software Name
LC6000	LCS6000
MULTI-TEC	MTS1000
FUSION-TEC (WR)	WTS1000
MEGA-TEC	MGS1000

Setpoints

Setpoints allows setting and enabling of comfort mode.

TABLE 7
LC6000 Status Messages

Message	Description
On	The LC6000 is ready and functioning properly.
Off by BMS	The LC6000 is being turned off by the Building Management System through Modbus TCP/IP.
Off by Keyboard	The LC6000 is turned off using the (D. On/Off) Menu on the PGD. All communicating units will be inactive.
Comfort Mode	The LC6000 is set to Comfort Mode. This mode is used to temporarily override heating/cooling setpoints and maintain a default temperature of 72°F for 60 minutes.
Emergency Cooling	A high temperature has been sensed in one or more zones. All available units in that zone are sent a command for emergency cooling. (Refer to unit manual for emergency cooling sequence.)
Emergency Vent	Input signal from an external device at terminal DI2 (e.g., hydrogen detector). Units that are equipped with a ventilation option and configured will open the dampers at 100% with the blower at full speed. Refer to Emergency Vent Alarm Operation on page 20.

Additional Programming

Changing to Celsius

1. Press MENU key to go to the Main Menu screen.
2. Use UP or DOWN keys and ENTER key to enter USER password 2000.
3. Press UP or DOWN keys to scroll to **Sys Config**; press ENTER key.
4. Press UP or DOWN keys to scroll to **General Settings (A1-1)**; press enter key.
5. Press ENTER key to scroll to **UOM** (see Figure 39).
6. Press UP and DOWN keys to change value to **SI**.

FIGURE 39
Changing to Celsius

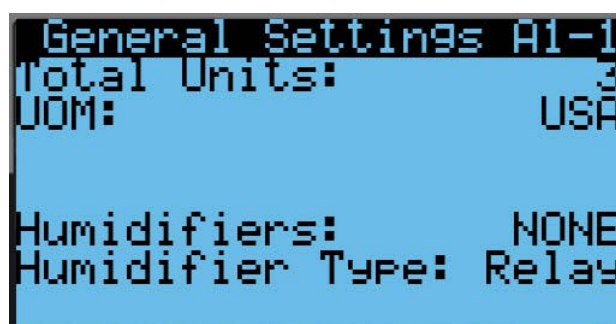

Configuring Number of Units

The LC is capable of operating up to 14 wall-mount units in up to 3 zones. This includes MULTI-TEC, FUSION-TEC WR Series and MEGA-TEC units. Add all units up for total number of units. Example: If there are three MULTI-TEC units in Zone 1, two FUSION-TEC WR units in Zone 2 and one MEGA-TEC unit in Zone 3, the total number of units should be set to 6.

To configure the total number of units:

1. Press MENU key to go to the Main Menu screen.
2. Press UP or DOWN keys and ENTER key to enter USER password 2000.
3. Press UP or DOWN keys to scroll to **Sys Config**; press ENTER key.
4. Press UP or DOWN keys to scroll to **General Settings (A1-1)**; press enter key.
5. Press ENTER key to scroll to **Total Units** (see Figure 39).
6. Press UP or DOWN keys to adjust value to correct number of units.
7. Press ENTER key to save value.

Calibrating Sensors

1. Press MENU key to go to the Main Menu screen.
2. Use UP or DOWN keys and ENTER key to enter USER password 2000.

3. Press UP or DOWN keys to scroll to **I/O Config**; press ENTER key.
4. Press UP or DOWN keys to scroll to sensor to be adjusted.
5. Press ENTER key to scroll to **Offset**.
6. Press UP or DOWN keys to add or subtract to the sensor offset value.
7. Press ENTER key to save.

Clearing Alarm Logs

1. Press MENU key to go to the Main Menu screen.
2. Use UP or DOWN keys and ENTER key to enter USER password 2000.
3. Press UP or DOWN keys to scroll to **Settings**; press ENTER key.
4. Press UP or DOWN keys to scroll to **Initialization**; press ENTER key.
5. Press ENTER key to scroll to **Delete Alarm Logs?** (see Figure 40).
6. Press UP or DOWN key to change value to **YES**; press ENTER key.

FIGURE 40
Clearing LC6000 Alarm Logs

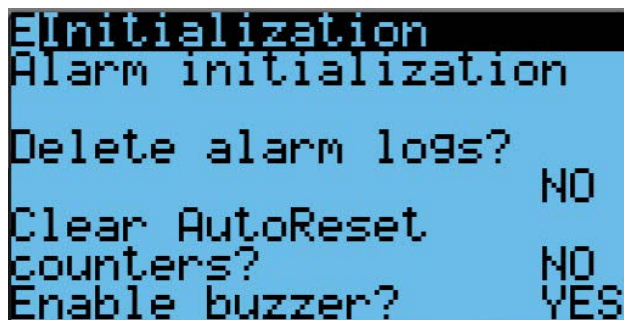

Configuring Free Cooling

Each zone can be configured to operate the economizers with different considerations. For more information on the economizer enable setpoints, please reference the most recent version of the corresponding wall-mount unit service manual. For MULTI-TEC, see Service Manual 2100-712. For FUSION-TEC WR Series, see Service Manual 2100-695. For MEGA-TEC W090-150 units, see Service Manual 2100-671. For MEGA-TEC W180 units, see Service Manual 2100-749.

The type of consideration can be changed to none, drybulb, temperature and humidity, or enthalpy. The temperature, humidity and dewpoint parameters can be changed to affect at what conditions the economizers in the respective zone will operate. These settings will be communicated to the wall units while connected to the LC6000 to ensure all units operate the same.

To make changes to the free cooling settings:

1. Press MENU key to go to the Main Menu screen.
2. Use UP or DOWN keys and ENTER key to enter USER password 2000.
3. Press UP or DOWN keys to scroll to **Sys Config**; press ENTER key.
4. Press UP or DOWN keys to scroll to **Zone 1, Zone 2** or **Zone 3**; press ENTER key.
5. Press UP or DOWN keys to scroll to **Zone FC Settings A2-4** (Zone 1), **Zone FC Settings A3-4** (Zone 2) or **Zone FC Settings A4-4** (Zone 3).
6. Press ENTER key to scroll to **Type, Enable Temp, Enable Hum** or **Enable DewP** (see Figure 41).
7. Press UP and DOWN keys to adjust free cooling values.

FIGURE 41
Configuring Free Cooling

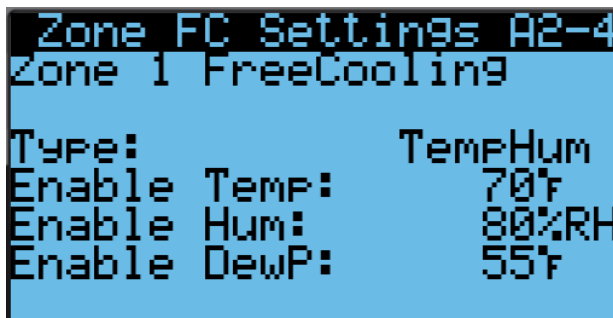

Enabling High Sensible Operation

The LC6000 has the option to operate the wall units in a high sensible mode that will adjust blower speeds to enhance the sensible cooling capacity of the units. This option is not enabled by default and will automatically turn off when the indoor humidity raises to the passive dehumidification setpoint. High sensible operation will resume once the indoor humidity has lowered to the dehumidification off setpoint.

NOTE: *This mode is available only on the FUSION-TEC WR Series, MEGA-TEC wall-mount units and 11EER MULTI-TEC wall-mount units.*

To enable high sensible operation:

1. Press MENU key to go to the Main Menu screen.
2. Use UP or DOWN keys and ENTER key to enter USER password 2000.
3. Press UP or DOWN keys to scroll to **Sys Config**; press ENTER key.
4. Press UP or DOWN keys to scroll to **Zone 1, Zone 2** or **Zone 3**; press ENTER key.

5. Press UP or DOWN keys to scroll to **Blower Profile A2-12** (Zone 1), **Blower Profile A3-12** (Zone 2) or **Blower Profile A4-12** (Zone 3).
6. Press ENTER key to scroll to **Enable** (see Figure 42).
7. Press UP or DOWN key to change value to **YES**; press ENTER key.

FIGURE 42
Enabling High Sensible Operation

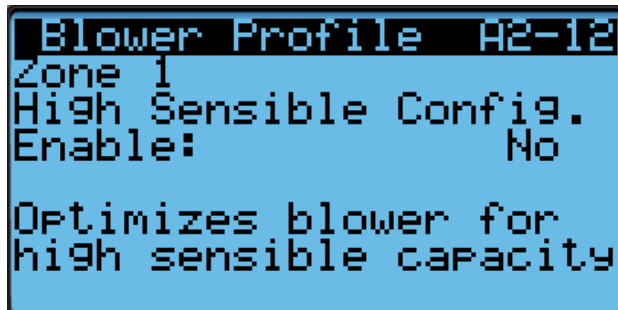

TABLE 8
LC6000-200 Terminal Block Index

TB#	Wire Mark	Description
1	-	120 VAC Input
2	-	208 VAC Input
3	-	230 VAC Input
4	-	Power Input Common
5	-	Power Input Ground
6	DI1	Emergency Off Input
7	GND	Emergency Off Common
8	DI2	Emergency Vent Input
9	GND	Emergency Vent Common
10	DI3	Generator Run Input
11	GND	Generator Run Common
12	B2	Zone 1 Indoor Remote Humidity Sensor
13	GND	Ground
14	B3	Zone 2 Indoor Remote Humidity Sensor
15	GND	Ground
16	B4	Zone 3 Indoor Remote Humidity Sensor
17	GND	Ground
18	B6	Zone 1 Indoor Temperature Sensor
19	GND	Ground
20	B7	Zone 1 Indoor Remote Temperature Sensor
21	GND	Ground
22	VDC+	Power for B2 (Z1 Humidity)
23	VDC+	Power for B3 (Z2 Humidity)
24	VDC+	Power for B4 (Z3 Humidity)
25	VDC+	Power for B10 (Pressure)
26	B8	Zone 2 Indoor Remote Temperature Sensor
27	GND	Ground
28	B9	Zone 3 Indoor Remote Temperature Sensor
29	GND	Ground
30	B10	Indoor Space Pressure
31	GND	Ground
32	NO1	Humidifier 1
33	C1	Common
34	NO2	Humidifier 2
35	C1	Common
36	NO3	Humidifier 3
37	C1	Common
38	NO4	Emergency Off Alarm

TB#	Wire Mark	Description
39	C4	Common
40	NO5	Emergency Vent Alarm
41	C4	Common
42	NO6	Generator Run Alarm
43	C4	Common
44	NO7	Indoor Humidity Alarm
45	C7	Common
46	NO8	High Indoor Temperature Alarm
47	C8	Common
48	NO9	Low Indoor Temperature Alarm
49	C8	Common
50	NO10	Zone 1 Unit Alarm
51	C8	Common
52	NO11	Zone 2 Unit Alarm
53	C8	Common
54	NO12	Zone 3 Unit Alarm
55	C8	Common
56	FB1R-	RS485 RX- / TX- (Fieldbus 1) UNIT CONNECTION
57	FB1R+	RS485 RX+ / TX+ (Fieldbus 1) UNIT CONNECTION
58	FB2R-	RS485 RX- / TX- (Fieldbus 2)
59	FB2R+	RS485 RX+ / TX+ (Fieldbus 2)
60	--	Power Input Ground
61	24 VAC+	24 VAC Supply
62	--	Not Used
63	24 VAC+	24 VAC Supply
64	24 VAC-	24 VAC Ground
65	24 VAC+	24 VAC Supply for Outdoor Humidity Sensor
66	24 VAC-	24 VAC Ground for Outdoor Humidity Sensor
67	B11	Signal for Outdoor Humidity Sensor
68	24 VAC+	24 VAC Supply
69	D14	Bard Guard Alarm Signal
70	B12	Signal for Outdoor Temperature Sensor
71	GND	Ground for Outdoor Temperature Sensor
72	GND	Ground for Bard Guard Alarm Signal
73	G	Orange Power Connector
74	24 VAC+	24 VAC Supply
75	G0	Orange Power Connector
76	24 VAC-	24 VAC Ground

TABLE 9
LC6000-200 to Sensor Connection Index

LC6000		Sensor	Terminal	Description
TB#	Wire Mark			
12	B2	8403-079 (Indoor Temp/Hum)	OUT H	Zone 1 Indoor Remote Humidity Sensor
13	GND	8403-079 (Indoor Temp/Hum)	M (GO)	Ground
14	B3	8403-079 (Indoor Temp/Hum)	OUT H	Zone 2 Indoor Remote Humidity Sensor
15	GND	8403-079 (Indoor Temp/Hum)	M (GO)	Ground
16	B4	8403-079 (Indoor Temp/Hum)	OUT H	Zone 3 Indoor Remote Humidity Sensor
17	GND	8403-079 (Indoor Temp/Hum)	M (GO)	Ground
18	B6	8403-079 (Indoor Temp/Hum)	NTC OUT	Zone 1 Indoor Temperature Sensor
19	GND	8403-079 (Indoor Temp/Hum)	NTC OUT	Ground
20	B7	8301-058 (Indoor Temp Only)	NTC OUT	Zone 1 Indoor Remote Temperature Sensor
21	GND	8301-058 (Indoor Temp Only)	NTC OUT	Ground
22	VDC+	8403-079 (Indoor Temp/Hum)	+ (G)	Power for B2 (Z1 Humidity)
23	VDC+	8403-079 (Indoor Temp/Hum)	+ (G)	Power for B3 (Z2 Humidity)
24	VDC+	8403-079 (Indoor Temp/Hum)	+ (G)	Power for B4 (Z3 Humidity)
26	B8	8403-079 (Indoor Temp/Hum)	NTC OUT	Zone 2 Indoor Remote Temperature Sensor
27	GND	8403-079 (Indoor Temp/Hum)	NTC OUT	Ground
28	B9	8403-079 (Indoor Temp/Hum)	NTC OUT	Zone 3 Indoor Remote Temperature Sensor
29	GND	8403-079 (Indoor Temp/Hum)	NTC OUT	Ground
65	24 VAC+	8301-090 (Outdoor Temp/Hum)	2	24 VAC Supply for Outdoor Humidity Sensor
66	24 VAC-	8301-090 (Outdoor Temp/Hum)	3	24 VAC Ground for Outdoor Humidity Sensor
67	B11	8301-090 (Outdoor Temp/Hum)	1	Signal for Outdoor Humidity Sensor
69	D14	Bard Guard	14	Bard Guard Alarm Signal
70	B12	8301-090 (Outdoor Temp/Hum)	4	Signal for Outdoor Temperature Sensor
71	GND	8301-090 (Outdoor Temp/Hum)	5	Ground for Outdoor Temperature Sensor
72	GND	Bard Guard	15	Ground for Bard Guard Alarm Signal

FIGURE 43
LC6000-200 Wiring Diagram

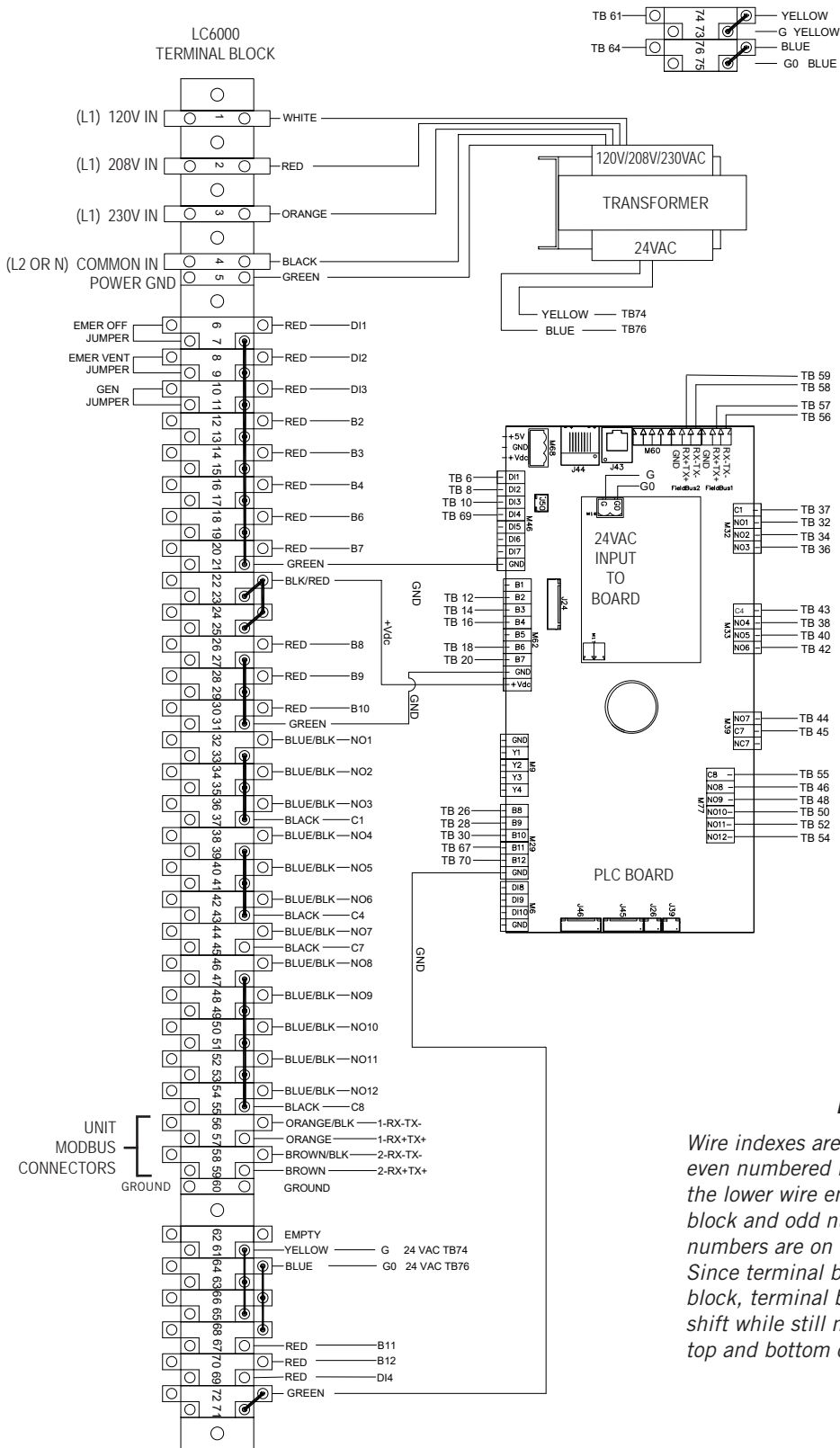

NOTE:

Wire indexes are identified such that even numbered index numbers are on the lower wire entries of the terminal block and odd numbered index numbers are on the top wire entries. Since terminal block 60 is a ground block, terminal blocks 61 thru 72 shift while still maintaining the same top and bottom configuration.

LC6000 Controller and Unit Feature Matrix



MULTI-TEC Unit



FUSION-TEC WR Unit



MEGA-TEC Unit

Feature	MULTI-TEC	FUSION-TEC WR	MEGA-TEC
Unit Airflow Path	Upflow	Counterflow	Upflow
Cooling Stages	1	2	3
Cooling Refrigerant Circuits Per Unit	1	1	2
Indoor and Outdoor Fan Control	Select Speed	0-10V	Modbus
Heating Stages	2	2	2
Electric Reheat Dehumidification	Optional	No	Optional
Mechanical Hot Gas Dehumidification	Optional	No	No
Balanced Climate Humidity Removal Mode	Yes	Yes	Yes
High Sensible Cooling Mode	Yes	Yes	Yes
Economizer Free Cooling	Optional	Yes	Optional
Orphan Mode	Yes	Yes	Yes
Emergency Ventilation Mode	Economizer model only	Yes	Economizer model only
Emergency Cooling Mode	Economizer model only	Yes	Economizer model only
Emergency Off	Yes	Yes	Yes
Superheat Display	No	Yes	Yes
Subcooling Display	No	Yes	Yes
Low Pressure Display	No	Yes	Yes
High Pressure Display	No	Yes	Yes
Electronic Expansion Valve Display	No	Yes	Yes
Bard Guard Alarm	No	Optional	No
Dirty Filter Alarm	Yes	Yes	Yes
Indoor Fan Failure Alarm	No	Yes	Yes
High Refrigerant Pressure Alarm	Yes	Yes	Yes
Low Refrigerant Pressure Alarm	Yes	Yes	Yes
Supply Air Temperature	No	Yes	Yes
Return Air Temperature	Yes	Yes	Yes
Mixed Air Temperature	Economizer model only	Yes	Yes
Outdoor Air Temperature	Economizer model only	Yes	Yes
Outdoor Air Humidity	Economizer model only	Yes	Yes

LC6000 I/O Input Matrix

Inputs	Input Config	Input Default	Description
Zone 1 Temp/Humidity	5 - wire	NA	5 wire connections for temperature/humidity sensor
Zone 1 Temp Only	2 - wire	NA	2 wire connections for temperature/humidity sensor
Zone 2 Temp/Humidity	5 - wire	NA	5 wire connections for temperature/humidity sensor
Zone 3 Temp/Humidity	5 - wire	NA	5 wire connections for temperature/humidity sensor
Outdoor Temp/Humidity	5 - wire	NA	5 wire connections for temperature/humidity sensor
Emergency Off	NO/NC Contacts	NC	Connection for unit shutdown
Emergency Vent	NO/NC Contacts	NC	Connection for economizer fully open ventilation
Generator Run	NO/NC Contacts	NC	Connection to signal a generator is running
Room Pressure Sensor	NO/NC Contacts	NO	Connection for room pressure sensor (future use)
Bard Guard Alarm	NO/NC Contacts	NO	Connection for Bard Guard (FUSION-TEC WR only)

LC6000 I/O Output Matrix

Outputs	Output Config	Output Default	Description
Emergency Vent Alarm	NO/NC Contacts	NO	Emergency ventilation mode is currently active.
Generator Run Alarm	NO/NC Contacts	NO	Generator run mode is currently active.
Emergency Off Alarm	NO/NC Contacts	NO	Emergency off mode is currently active.
Humidity Alarm	NO/NC Contacts	NO	Humidity Hi/Lo alarm is active in a zone.
Hi Indoor Temp Alarm	NO/NC Contacts	NO	High temp 2 alarm is currently active in a zone.
Low Indoor Temp Alarm	NO/NC Contacts	NO	Low temp alarm is currently active in a zone.
Zone 1 Alarm	NO/NC Contacts	NO	An alarm event is active in zone 1.
Zone 2 Alarm	NO/NC Contacts	NO	An alarm event is active in zone 2.
Zone 3 Alarm	NO/NC Contacts	NO	An alarm event is active in zone 3.
Bard Guard Alarm	NO/NC Contacts	NO	A Bard Guard Alarm event is active.

8403-079 Remote Indoor Temperature/Humidity Sensor

Troubleshooting the temperature/humidity sensor is necessary if the temperature or humidity reading for a zone is inaccurate. Always start sensor troubleshooting by verifying connections at the sensor board and at the LC6000 terminal blocks. Improper connection will cause inaccurate readings. Next, verify continuity at both ends of wires running between the sensor and the LC6000. A severed or damaged wire will cause inaccurate readings. As a last step, verify voltage and resistance at the sensor and the LC6000 terminal block per Tables 10 and 11 on pages 42 and 43. If the sensor is found to be malfunctioning, replace the sensor.

FIGURE 44
8403-079 Sensor

Sensor Terminals	Description
M(GO) - +(G)	12VDC +/- Supplies power to the sensor
M(GO) - OUT H	0-1VDC Supplies signal for zone humidity (see Voltage/Humidity chart on page 43)
NTC OUT - NTC OUT	Ohm Supplies signal for zone temperature (see Temperature/Resistance chart on page 42)

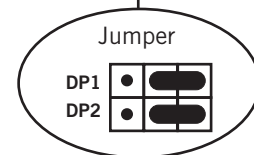
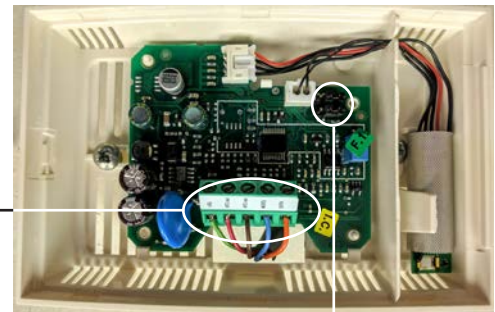

0-1VDC Jumper Position

NOTE: Sensor jumper must be positioned for 0-1 V as shown above for sensor to function properly.

Current versions of the 8403-079 remote indoor temperature/humidity sensor need to be installed with the shielded cable wires entering the bottom of the back of the sensor to connect to the sensor terminals as shown above in Figure 44. Earlier versions of this sensor were installed so that the sensor wires entered through the top of the back of the sensor. See **Remote Indoor Temperature/Humidity Sensor Orientation** on page 44 for more information.

TABLE 10
8403-079 Sensor: Temperature/Resistance

Temperature		Resistance	Temperature		Resistance	Temperature		Resistance	Temperature		Resistance
C	F	KΩ	C	F	KΩ	C	F	KΩ	C	F	KΩ
-18	0	61.52	0	32	27.28	18	64	13.06	36	97	6.69
-17	1	58.66	1	34	26.13	19	66	12.56	37	99	6.46
-16	3	55.95	2	36	25.03	20	68	12.09	38	100	6.24
-15	5	53.39	3	37	23.99	21	70	11.63	39	102	6.03
-14	7	50.96	4	39	22.99	22	72	11.20	40	104	5.82
-13	9	48.65	5	41	22.05	23	73	10.78	41	106	5.63
-12	10	46.48	6	43	21.15	24	75	10.38	42	108	5.43
-11	12	44.41	7	45	20.29	25	77	10.00	43	109	5.25
-10	14	42.25	8	46	19.40	26	79	9.63	44	111	5.08
-9	16	40.56	9	48	18.70	27	81	9.28	45	113	4.91
-8	18	38.76	10	50	17.96	28	82	8.94	46	115	4.74
-7	19	37.05	11	52	17.24	29	84	8.62	47	117	4.59
-6	21	35.43	12	54	16.55	30	86	8.31	48	118	4.44
-5	23	33.89	13	55	15.90	31	88	8.01	49	120	4.30
-4	25	32.43	14	57	15.28	32	90	7.72	50	122	4.16
-3	27	31.04	15	59	14.68	33	91	7.45	51	124	4.02
-2	28	29.72	16	61	14.12	34	93	7.19	52	126	3.90
-1	30	28.47	17	63	13.57	35	95	6.94			

TABLE 11
8403-079 Sensor: Voltage/Humidity

Voltage DC	RH%	Voltage DC	RH%	Voltage DC	RH%	Voltage DC	RH%
1	100	0.74	74	0.49	49	0.24	24
0.99	99	0.73	73	0.48	48	0.23	23
0.98	98	0.72	72	0.47	47	0.22	22
0.97	97	0.71	71	0.46	46	0.21	21
0.96	96	0.70	70	0.45	45	0.20	20
0.95	95	0.69	69	0.44	44	0.19	19
0.94	94	0.68	68	0.43	43	0.18	18
0.93	93	0.67	67	0.42	42	0.17	17
0.92	92	0.66	66	0.41	41	0.16	16
0.91	91	0.65	65	0.40	40	0.15	15
0.90	90	0.64	64	0.39	39	0.14	14
0.89	89	0.63	63	0.38	38	0.13	13
0.88	88	0.62	62	0.37	37	0.12	12
0.87	87	0.61	61	0.36	36	0.11	11
0.86	86	0.60	60	0.35	35	0.10	10
0.85	85	0.59	59	0.34	34	0.09	9
0.84	84	0.58	58	0.33	33	0.08	8
0.83	83	0.57	57	0.32	32	0.07	7
0.82	82	0.56	56	0.31	31	0.06	6
0.81	81	0.55	55	0.30	30	0.05	5
0.79	79	0.54	54	0.29	29	0.04	4
0.78	78	0.53	53	0.28	28	0.03	3
0.77	77	0.52	52	0.27	27	0.02	2
0.76	76	0.51	51	0.26	26	0.01	1
0.75	75	0.50	50	0.25	25	0.00	0

Remote Indoor Temperature/Humidity Sensor Orientation

Current versions of the remote indoor temperature/humidity sensor need to be installed with the shielded cable wires entering the bottom of the back of the sensor to connect to the sensor terminals (see Figure 45). Earlier versions of this sensor were installed so that the sensor wires entered through the top of the back of the sensor (see Figure 46). **The orientation of the sensor affects the position of the DP1/DP2 jumpers. Depending on how the sensor is installed, be sure to confirm that the jumpers are in the proper position for the 0-1 V setting as shown in the figures below.**

This applies to all indoor temperature/humidity sensors connected to the LC controller. See illustration mounted inside of sensor cover for further detail on jumper position.

FIGURE 45
Current Sensor Orientation
(Shielded Cable Wires Enter from Bottom)

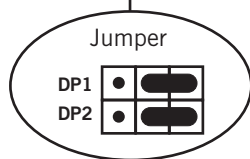
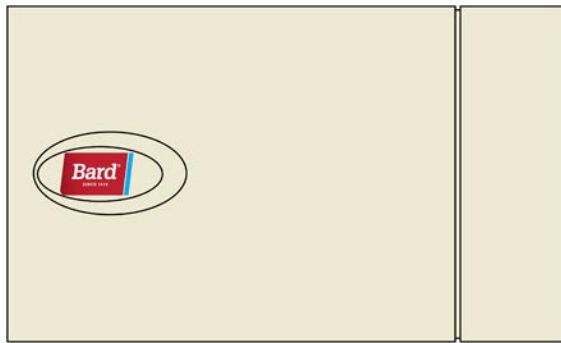

DP1 and DP2 Jumpers
 Positioned for 0-1V
 (Current Orientation)

FIGURE 46
Earlier Sensor Orientation
(Shielded Cable Wires Enter from Top)

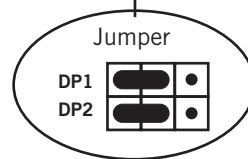
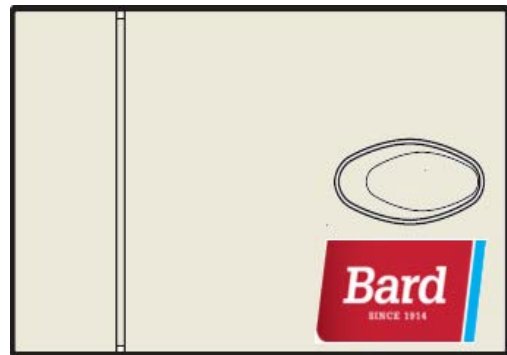

DP1 and DP2 Jumpers
 Positioned for 0-1V
 (Earlier Orientation)

8301-090 Outdoor Temperature/Humidity Sensor

Troubleshooting the temperature/humidity sensor is necessary if the temperature or humidity reading is inaccurate. Always start sensor troubleshooting by verifying connections at the sensor board and at the LC6000 terminal blocks. Improper connection will cause inaccurate readings. Next, verify continuity at both ends of wires running between the sensor and the LC6000. A severed or damaged wire will cause inaccurate readings. As a last step, verify voltage and resistance at the sensor and the LC6000 terminal block per the provided table. If the sensor is found to be malfunctioning, replace the sensor.

FIGURE 47
8301-090 Sensor

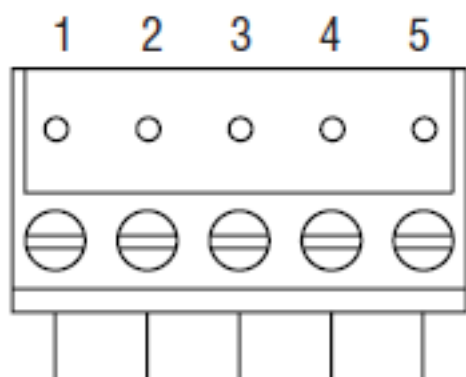

Sensor Terminal	Description
1	Remote Outdoor Humidity Sensor: 0-10 VDC
2	+VDC
3	Ground
4	Remote Outdoor Temperature Sensor
5	Ground

TABLE 12
8301-090 Sensor: Temperature/Resistance

Temperature			Resistance			Temperature			Resistance			Temperature			Resistance		
C	F	Ω	C	F	Ω	C	F	Ω	C	F	Ω	C	F	Ω	C	F	Ω
-32	-25.6	151,200	-10	14.0	47,540	12	53.6	17,210	34	93.2	7016						
-31	-23.8	142,900	-9	15.8	45,270	13	55.4	16,480	35	95.0	6752						
-30	-22.0	135,200	-8	17.6	43,110	14	57.2	15,790	36	96.8	6500						
-29	-20.2	127,900	-7	19.4	41,080	15	59.0	15,130	37	98.6	6258						
-28	-18.4	121,100	-6	21.2	39,140	16	60.8	14,500	38	100.4	6027						
-27	-16.6	114,600	-5	23.0	37,310	17	62.6	13,900	39	102.2	5805						
-26	-14.8	108,600	-4	24.8	35,580	18	64.4	13,330	40	104.0	5592						
-25	-13.0	102,900	-3	26.6	33,930	19	66.2	12,780	41	105.8	5389						
-24	-11.2	97,490	-2	28.4	32,370	20	68.0	12,260	42	107.6	5194						
-23	-9.4	92,420	-1	30.2	30,890	21	69.8	11,770	43	109.4	5007						
-22	-7.6	87,650	0	32.0	29,490	22	71.6	11,290	44	111.2	4827						
-21	-5.8	83,150	1	33.8	28,160	23	73.4	10,840	45	113.0	4655						
-20	-4.0	78,910	2	35.6	26,890	24	75.2	10,410	46	114.8	4490						
-19	-2.2	74,910	3	37.4	25,690	25	77.0	10,000	47	116.6	4331						
-18	-0.4	71,130	4	39.2	24,540	26	78.8	9602	48	118.4	4179						
-17	1.4	67,570	5	41.0	23,460	27	80.6	9226	49	120.2	4033						
-16	3.2	64,200	6	42.8	22,430	28	82.4	8866	50	122.0	3893						
-15	5.0	61,020	7	44.6	21,440	29	84.2	8522	51	123.8	3758						
-14	6.8	58,010	8	46.4	20,510	30	86.0	8194	52	125.6	3629						
-13	8.6	55,170	9	48.2	19,620	31	87.8	7879									
-12	10.4	52,490	10	50.0	18,780	32	89.6	7579									
-11	12.2	49,950	11	51.8	17,980	33	91.4	7291									

LC6000 REPLACEMENT PARTS LIST

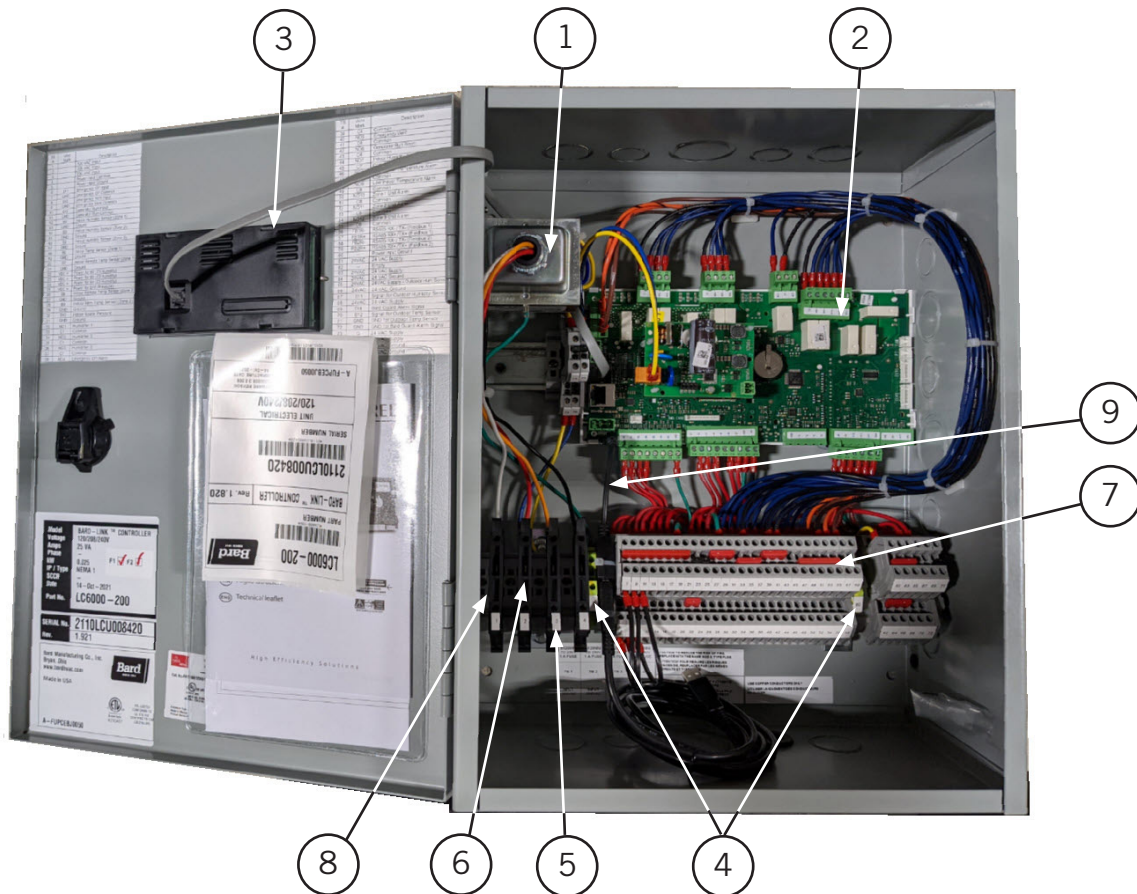

Dwg. No.	Part No.	Description	
1	8407-074	Transformer	X
2	8301-099-001 ①	UPC3 C2 LC6000 ②③	X
3	8301-053	pGDEvolution Panel Display	X
4	8607-052	Grounded Terminal Block	2
5	8614-059	1.0 Amp Fuse	4
6	8607-039	Fused Terminal Block	4
7	8607-057	Terminal Block Double Level	54
8	8611-144	End Clamp (for Din Rail)	6
9	8301-075	USB Micro Cable Female to Male	X
NS	8301-055	EMI Ferrite Filter	2
NS	8403-079	Remote Temperature/Humidity Sensor	X
NS	8301-058	Remote Temperature Sensor ④	X
NS	8301-090	Outdoor Temperature/Humidity Sensor ④	X
NS	8301-059	TEC-EYE (Service Tool), 5' Telephone Cable	X

① Replacement part will have a letter attached to the end of the part number to designate software version (Example: 8301-099-001A). A software upgrade of all PLCs onsite (units and controllers) should accompany any PLC replacement. Latest revisions of software, change log and instructions are available on the Bard website at <http://www.bardhvac.com/software-download/>

② uPC3 PLC board digital output ratings. Type: A (SPST) with a rating of AC 230V 3(1)A 100k cycles, 250 Vac FLA 1A, LRA 6A Definite Purpose 30k cycles, 250 Vac, 3A resistive, 50k cycles, C300 pilot duty, 30k cycles. (EN60730-1, UL60730)

③ Batteries for the control boards are field supplied. Supplier part number is BR2032.

④ Optional NS – Not Shown