

---

# INSTALLATION INSTRUCTIONS

---

## Bard Air Conditioning System



**FUSION-TEC®  
WR Series  
Wall-Mount  
Air Conditioner**



**LC6000-200  
Supervisory  
Controller**



Climate Control Solutions

Bard Manufacturing Company, Inc.  
Bryan, Ohio 43506  
www.bardhvac.com

Manual: 2100-704F  
Supersedes: 2100-704E  
Date: 10-22-21

# CONTENTS

## General Information .....4

Air Conditioning System.....	4
Wall-Mount Air Conditioner Units.....	4
Controller.....	4
General.....	5
Shipping Damage.....	5
Additional Publications.....	5

## List of Necessary Materials/Tools.....6

### Site Preparation.....7

Model Identification.....	7
New Shelter Installation vs. Retrofit Installation ..	7
Minimum Clearance.....	8
Clearance to Combustibles.....	8

### Wall-Mount Unit Mounting.....10

Mounting the Units.....	10
Supply Air Grill Installation.....	12

### Wall-Mount Unit Wiring .....18

Main Power Wiring.....	18
Unit Control Voltage Wiring.....	20

### Preliminary Start Up.....22

Running in Orphan Mode.....	22
-----------------------------	----

### LC6000 Controller Installation.....23

LC6000 Controller.....	24
Mounting the LC Controller.....	24
Installing Remote Indoor Temperature/Humidity Sensor(s).....	25
Installing Outdoor Temperature/Humidity Sensor.....	27
Emergency Off, Emergency Ventilation and Generator Run Connections.....	28
Communication Wiring.....	29
Supply Wiring.....	34

### System Set Up .....37

TEC-EYE™ Hand-Held Diagnostic Tool.....	37
Tec-Eye Status Screen.....	37
Setting Up Wall-Mount Units for Operation.....	38
1. Address Each Wall-Mount Unit.....	38
2. Execute a Self Test on Each Unit.....	38
3. Clear Unit Alarm Logs on Each Unit.....	39
Setting Up LC6000 for Operation.....	39
4. Set LC Controller Date and Time.....	39
5. Configure Sensors.....	40
6. Enter Total Number of Units.....	42
7. Verify Units are Online.....	43
8. Select Economizer Type for Each Zone ..	43
9. Clear Controller Alarm Logs.....	43
10. Complete Installation.....	44

### Additional Information.....45

Menu Screens and Password Levels.....	45
Setpoints.....	45
Calibrating Sensors.....	45
Remote Indoor Temperature/Humidity Sensor Orientation.....	47

## FIGURES

Figure 1	WR Series Model Nomenclature.....	7
Figure 2	Dimensions.....	9
Figure 3	Prefilling Traps on Indoor Drain Pan Hoses.....	11
Figure 4	Hanging Front Access Panel to Allow Access to Control Panel.....	11
Figure 5	Fold-Out Diverter.....	12
Figure 6	Downward Curved Diverter Blades.....	12
Figure 7	View of Installed Grille.....	12
Figure 8	WR35 Mounting Instructions.....	13
Figure 9	WR36/58 Mounting Instructions.....	14
Figure 10	Electric Heat Clearance.....	15
Figure 11	Wall Mounting Instructions.....	15
Figure 12	Wall Mounting Instructions.....	16
Figure 13	Common Wall Mounting Installations..	17
Figure 14	Wire Routing.....	19
Figure 15	<b>WIRING:</b> VAC Supply Wiring Landing Points.....	19
Figure 16	Side Communication and Power Wire Entrances (Recommended).....	19
Figure 17	Rear Communication and Power Wire Entrances (Optional).....	20
Figure 18	Adjusting the 230/208 VAC Transformer.....	21
Figure 19	Cool and Heat Setpoints.....	22
Figure 20	Typical LC6000-200 Component Location.....	23
Figure 21	LC6000 Fused Power Supply Terminals..	24
Figure 22	Remote Indoor Temperature/Humidity Sensor Installation.....	25
Figure 23	Additional Remote Sensor Installation ..	26
Figure 24	Remote Outdoor Temperature/Humidity Sensor Installation.....	27
Figure 25	Emergency Off, Emergency Ventilation and Generator Run Connections.....	28
Figure 26	Communication Wiring (Daisy Chain) ..	29
Figure 27	Communication Wiring (Alt. Method) ..	29
Figure 28	Placement of Communication Filters ..	30
Figure 29	Communication Wiring: Termination at the Controller.....	31
Figure 30	Communication Wiring: Termination at the First Wall-Mount Unit.....	32
Figure 31	Communication Wiring: Termination at Additional Wall-Mount Units.....	33
Figure 32	LC6000 Controller Supply Wiring.....	34
Figure 33	Controller Grounding Posts.....	34
Figure 34	<b>WIRING:</b> LC6000-200 Wiring Diagram ..	36
Figure 35	TEC-EYE Connection to Unit Control... ..	37
Figure 36	TEC-EYE Display and Interface.....	37
Figure 37	Changing Unit Setup Values.....	38
Figure 38	Executing Self Test.....	39
Figure 39	Clearing Unit Alarm Logs.....	39
Figure 40	LC6000 Controller Display/Interface... ..	39
Figure 41	Setting Controller Date and Time.....	40

Figure 42	Enable/Disable Zone 1 Indoor Humidity Sensor.....	40
Figure 43	Enable/Disable Zone 2 Indoor Humidity Sensor.....	40
Figure 44	Enable/Disable Zone 3 Indoor Humidity Sensor.....	41
Figure 45	Enable/Disable Zone 1 Indoor Temperature Sensor .....	41
Figure 46	Enable/Disable Zone 1 Remote Temperature Sensor .....	41
Figure 47	Enable/Disable Zone 2 Remote Temperature Sensor .....	41
Figure 48	Enable/Disable Zone 3 Remote Temperature Sensor .....	42
Figure 49	Enable/Disable Outdoor Air Humidity Sensor.....	42
Figure 50	Enable/Disable Outdoor Air Temperature Sensor .....	42
Figure 51	Total Units Displayed .....	43
Figure 52	Selecting Economizer Type .....	43
Figure 53	Clearing LC6000 Alarm Logs .....	44
Figure 54	Adjusting Sensor Offset Value .....	45
Figure 55	Current Sensor Orientation .....	47
Figure 56	Earlier Sensor Orientation.....	47

**TABLES**

Table 1	Clearance Required for Service Access and Adequate Condenser Airflow .....	8
Table 2	Minimum Clearance Required to Combustible Materials.....	8
Table 3	Electrical Specifications.....	18
Table 4	LC6000-200 Terminal Block Index ....	35
Table 5	LC6000/TEC-EYE Passwords (Default)	45
Table 6	WR Series Unit Status Messages.....	46
Table 7	LC6000 Status Messages.....	46

 **WARNING**

**Electrical shock hazard.**  
**Have a properly trained individual perform these tasks.**  
**Failure to do so could result in electric shock or death.**

 **WARNING**

**Fire hazard.**  
**Maintain minimum 1/4" clearance between the supply flange and combustible materials.**  
**Failure to do so could result in fire causing damage, injury or death.**

 **WARNING**

**Heavy item hazard.**  
**Use more than one person to handle unit.**  
**Failure to do so could result in unit damage or serious injury.**

 **CAUTION**

**Cut hazard.**  
**Wear gloves to avoid contact with sharp edges.**  
**Failure to do so could result in personal injury.**

# GENERAL INFORMATION

## Air Conditioning System

This Bard air conditioning system is composed of FUSION-TEC WR Series wall-mounted air conditioners matched with an LC6000 lead/lag controller. The wall mounts are specifically engineered for telecom/motor control center rooms.

**NOTE:** The LC6000 lead/lag controller and FUSION-TEC WR Series wall-mount units are designed specifically to work together. The controller cannot run other Bard models or other brands of systems, nor can other controllers run the WR Series wall-mount units. They are a complete system, and must be used together.

## Wall-Mount Air Conditioner Units

The Fusion-TEC WR Series wall-mount units operate on VAC power. The units will supply 100% of rated cooling airflow in free cooling mode with ability to exhaust the same amount through the unit itself without any additional relief openings in the shelter.

Each of these units are fully charged with refrigerant and may have optional auxiliary heat.

## Controller

LC6000 controller and accessories are shown below.

### LC6000-200 Series Controller and Accessories Included with Controller

(1) LC6000 Programmable Logic Controller

(1) TEC-EYE™ Hand-Held Diagnostic Tool  
Bard P/N 8301-059

(1) Remote Temperature/Humidity Sensor<sup>1</sup>  
Bard P/N 8403-079

(1) 35' 5-Wire 18 Gauge Shielded Cable

(2) Communication EMI Filters  
Bard P/N 8301-055

### Optional Sensors:

Outside Air  
Temperature/Humidity Sensor  
Bard P/N 8301-090

Remote  
Temperature/Humidity Sensor<sup>1</sup>  
Bard P/N 8403-079

Remote  
Temperature Only Sensor  
Bard P/N 8301-058

<sup>1</sup> One remote temperature/humidity sensor is included with the LC6000 controller. If the site in which the LC6000 controller will be used has more than one zone (maximum three zones per LC6000), additional remote temperature/humidity sensors (one sensor per zone) will need to be purchased and installed in the additional zones. One additional temperature-only sensor (Bard P/N 8301-058) may also be used in Zone 1 but will also need to be purchased separately. Additional temperature/humidity sensors require field-supplied 5-wire 18 gauge shielded cable. Temperature-only sensors require field-supplied 2-wire 18 gauge shielded cable.

## General

The equipment covered in this manual is to be installed by trained, experienced service and installation technicians.

The refrigerant system is completely assembled and charged. All internal wiring is complete.

The unit is designed for use without duct work. Flanges are provided for transition from unit to wall grilles. A field-supplied wall sleeve may be necessary between the supply and return flanges and grilles.

These instructions explain the recommended method to install the air cooled self-contained unit and the electrical wiring connections to the unit.

These instructions and any instructions packaged with any separate equipment required to make up the entire air conditioning system should be carefully read before beginning the installation. Note particularly any tags and/or labels attached to the equipment.

While these instructions are intended as a general recommended guide, they do not supersede any national and/or local codes in any way. Authorities having jurisdiction should be consulted before the installation is made. See **Additional Publications** for information on codes and standards.

Sizing of systems for proposed installation should be based on heat loss and heat gain calculations made according to methods of Air Conditioning Contractors of America (ACCA). The supply flange should be installed in accordance with the *Standards of the National Fire Protection Association for the Installation of Air Conditioning and Ventilating Systems of Other Than Residence Type, NFPA No. 90A, and Residence Type Warm Air Heating and Air Conditioning Systems, NFPA No. 90B*. Where local regulations are at a variance with instructions, installer should adhere to local codes.

## Shipping Damage

Upon receipt of equipment, the cartons should be checked for external signs of shipping damage. If damage is found, the receiving party must contact the last carrier immediately, preferably in writing, requesting inspection by the carrier's agent. These units must remain in upright position at all times.

## Additional Publications

These publications can help when installing the air conditioner. They can usually be found at the local library or purchased directly from the publisher. Be sure to consult the current edition of each standard.

National Electrical Code ..... ANSI/NFPA 70  
Standard for the Installation of Air Conditioning  
and Ventilating Systems ..... ANSI/NFPA 90A  
Standard for Warm Air Heating  
and Air Conditioning Systems ..... ANSI/NFPA 90B  
Load Calculation for Residential Winter  
and Summer Air Conditioning ..... ACCA Manual J

For more information, contact these publishers:

### Air Conditioning Contractors of America (ACCA)

1712 New Hampshire Ave. N.W.  
Washington, DC 20009  
Telephone: (202) 483-9370 Fax: (202) 234-4721

### American National Standards Institute (ANSI)

11 West Street, 13th Floor  
New York, NY 10036  
Telephone: (212) 642-4900 Fax: (212) 302-1286

### American Society of Heating, Refrigeration and Air Conditioning Engineers, Inc. (ASHRAE)

1791 Tullie Circle, N.E.  
Atlanta, GA 30329-2305  
Telephone: (404) 636-8400 Fax: (404) 321-5478

### National Fire Protection Association (NFPA)

Batterymarch Park  
P. O. Box 9101  
Quincy, MA 02269-9901  
Telephone: (800) 344-3555 Fax: (617) 984-7057

## ANSI Z535.5 Definitions:

**DANGER:** Indicate[s] a hazardous situation which, if not avoided, will result in death or serious injury. The signal word "DANGER" is to be limited to the most extreme situations. DANGER [signs] should not be used for property damage hazards unless personal injury risk appropriate to these levels is also involved.

**WARNING:** Indicate[s] a hazardous situation which, if not avoided, could result in death or serious injury. WARNING [signs] should not be used for property damage hazards unless personal injury risk appropriate to this level is also involved.

**CAUTION:** Indicate[s] a hazardous situation which, if not avoided, could result in minor or moderate injury. CAUTION [signs] without a safety alert symbol may be used to alert against unsafe practices that can result in property damage only.

**NOTICE:** [this header is] preferred to address practices not related to personal injury. The safety alert symbol shall not be used with this signal word. As an alternative to "NOTICE" the word "CAUTION" without the safety alert symbol may be used to indicate a message not related to personal injury.



# **LIST OF NECESSARY MATERIALS/TOOLS**

---

Additional hardware and miscellaneous supplies are needed for installation. These items are field supplied and must be sourced before installation. This list also includes tools needed for installation.

## **List of Materials/Tools**

- Personal protective equipment/safety devices/ anti-static wrist straps
- SGR-5W Supply Grille and RGR-5W Return Grille
- Field-fabricated sleeves (if necessary)
- Bottom mounting bracket #113-140 (optional)
- Fasteners sufficient for mounting the units such as 5/16" diameter anchor/lag bolts
- 7/8" diameter washers
- Fasteners appropriate for the shelter wall construction to attach the controller to the wall
- Commercial grade outdoor silicone sealant
- Miscellaneous hand and power tools and jobsite or shop materials
- Lifting equipment with the necessary capacity and rigging to safely move/install the systems
- Water to prime drain traps
- Electrical supplies
  - Various size circuit breakers for the shelter AC breaker box (see Table 3 on page 18)
  - High-voltage wire of various gauges (see Table 3)
  - 16 gauge minimum, 14 gauge maximum power wire to connect controller to shelter power source
  - 5-wire, 18 gauge shielded cable for remote temperature and humidity sensors (2-wire, 18 gauge shielded cable for temperature-only sensors)
  - Communication wire: 2-wire, 18 gauge, shielded with drain
  - 18 gauge non-shielded wire for connecting smoke detector, hydrogen detector and/or generator, if applicable, to controller
  - CAT 6 Ethernet cable of field-determined length (for remote communication, if applicable)
  - 2 hole grounding lug (to be used with supplied 1/4" bolts and nuts for grounding controller box)
  - Miscellaneous electrical supplies including rigid/flexible conduit and fittings, 2" x 4" junction boxes (one per temperature/humidity sensor), wire connectors and supports



## Model Identification

Identify the specific model using the model nomenclature information found in Figure 1 and the model/serial tag found on the unit. See Figure 2 on page 9 for dimensions and critical installation requirements.

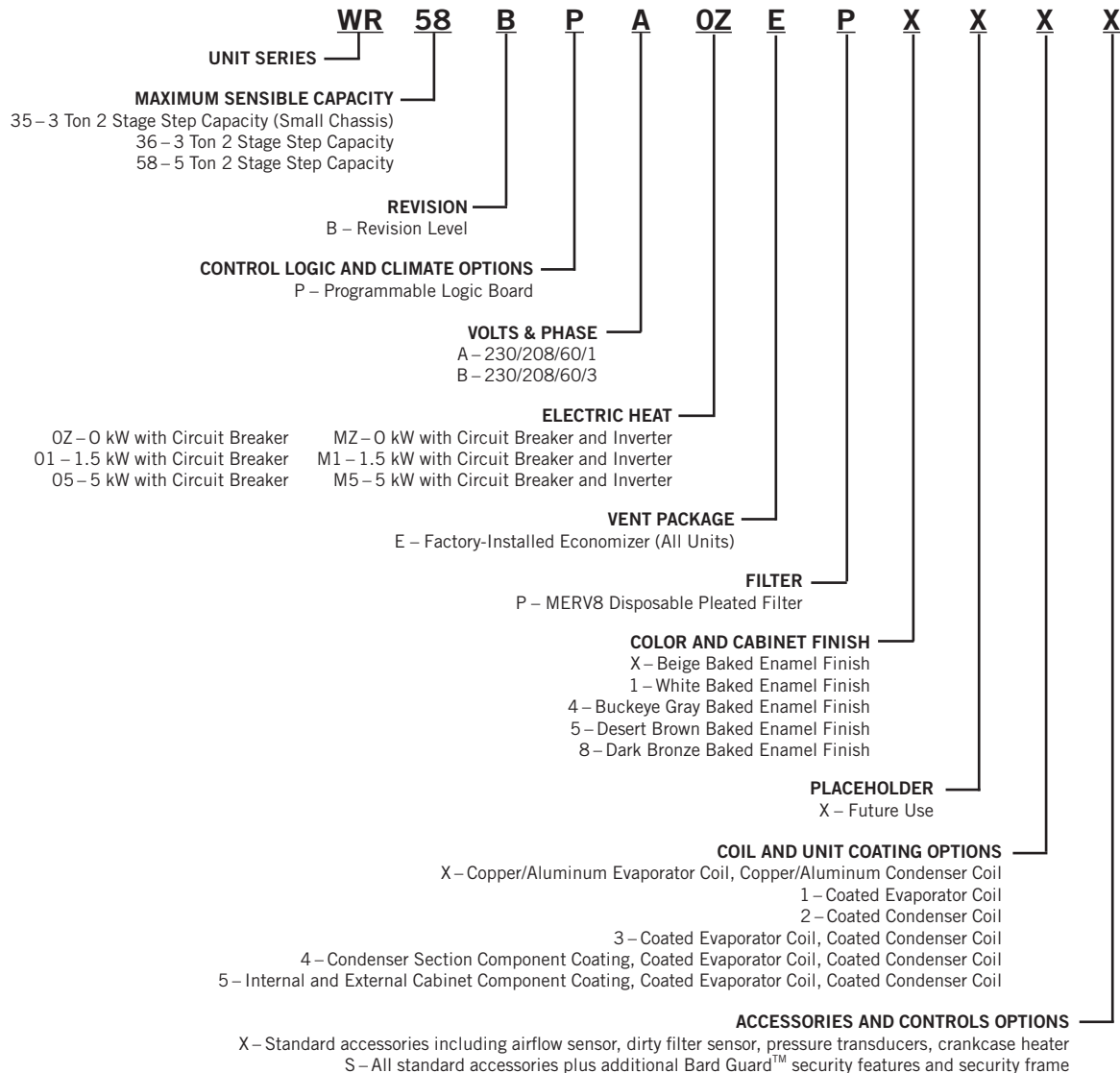
## New Shelter Installation vs. Retrofit Installation

These installation instructions cover both new shelter installations and retrofit installations. Each installation

is unique and may require special accommodations and modifications. Although Bard Manufacturing follows a long-established tradition of manufacturing equipment using industry standard dimensions for building penetration, it is occasionally necessary to move or enlarge supply and return openings when replacing non-standardized equipment in a retrofit application.

**IMPORTANT:** All retrofit installations require any existing supply and return grilles be removed and discarded. This is a counterflow unit and requires specified grilles to ensure proper system performance.

**FIGURE 1**  
**FUSION-TEC WR Series Wall-Mount Unit Model Nomenclature**



## Minimum Clearance

Counter flow wall-mount air conditioner models have a removable lower front service panel that allows access to the control panel, blower, compressor, circuit breakers and heat strip. There is a hinged access panel on both sides for filter change and evaporator coil service.

The upper side panel is removable to allow access to condenser fan, condenser coil and filter drier. The design allows for installations to place units within close proximity without complicating maintenance and repair.

To maintain full serviceability, side-by-side installations require 15" of clearance between units.

The condenser discharge air exits through the top of the unit. Although this reduces the potential for recirculation, it is still critical to system performance that any obstruction, shrubbery or structure adhere to minimum clearances listed (see Table 1).

For overhangs not exceeding 12" from exterior wall, minimum allowable clearance from top of unit to bottom of overhang should be no less than 5". For overhangs greater than 12" from exterior wall, minimum allowable clearance from top of unit to bottom of overhang should be no less than 10".

## Clearance to Combustibles

The unit itself is suitable for 0" clearance, but the supply air flange requires a minimum of 1/4" clearance to combustible material. However, it is generally recommended that a 1" clearance is used for ease of installation and maintaining the required clearance to combustible material. See Figure 8 on page 13 for details on opening sizes.

# WARNING

**Fire hazard.**

**Maintain minimum 1/4" clearance between the supply flange and combustible materials.**

**Failure to do so could result in fire causing damage, injury or death.**

**TABLE 1**  
**Clearance Required for Service Access and Adequate Condenser Airflow**

Model	Side(s)	Discharge (Top) Overhang 12" or less	Discharge (Top) Overhang Exceeding 12"	Intake (Base)	Front of Unit	Shelter Equipment from Supply Grille
WR35 WR36 WR58	15"	5"	10"	15" from Snowline	36"	24"

**TABLE 2**  
**Minimum Clearances Required to Combustible Materials**

Model	Supply Air Flange	Cabinet
WR35 WR36 WR58	1/4"	0"

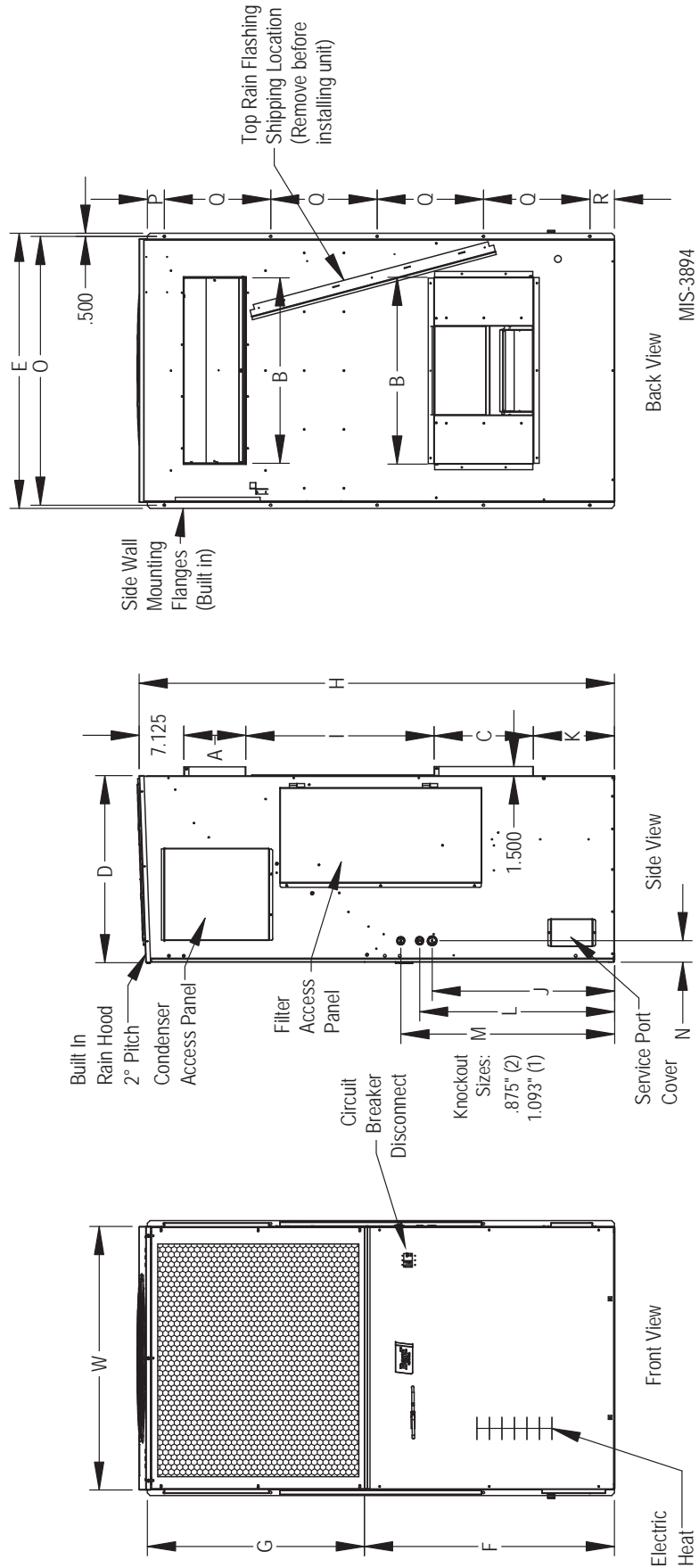


FIGURE 2

**Dimensions of Basic Unit for Architectural and Installation Requirements (Nominal)**

Model	Width (W)	Depth (D)	Height (H)	Return		Supply		A	B	C	D	E	F	G	H	I	J	K	L	M	N	O	P	Q	R
				A	B	C	D																		
WR35	36.86	27.33	71.61	7.75	27.75	13.77	27.75	41.88	29.73	18.06	31.08	21.27	33.08	36.08	34.45	37.92	2.33	16.00	3.92						
WR36	42.00	30.00	76.00	9.88	29.88	15.88	29.88	40.00	34.13	30.00	29.13	13.00	31.13	34.13	3.50	43.00	2.69	17.00	3.88						

All dimensions are in inches. Dimensional drawings are not to scale.



# WALL-MOUNT UNIT MOUNTING

## Mounting the Units

### **WARNING**

**Heavy item hazard.**

**Use more than one person to handle unit.**

**Failure to do so could result in unit damage or serious injury.**

**NOTE:** *It may be best to spot some electrical knockouts (such as those located on the sides of the wall-mount unit) before units are mounted and access is unavailable or limited (see Figure 2 to locate pre-punched knockouts).*

Two holes for the supply and return air openings must be cut through the wall as shown in Figure 8 on page 13. On wood frame walls, the wall construction must be strong and rigid enough to carry the weight of the unit without transmitting any unit vibration. All walls must be thoroughly inspected to ensure that they are capable of carrying the weight of the installed unit.

In retrofit (unit replacement) installations, the openings cut for the original equipment may not line up exactly with needs of this installation. Modifications may need to be made, such as increasing or decreasing the size of the wall cutouts. The existing bolt placement may not line up in which case the original bolts would need to be removed or cut away.

These units are secured by full-length mounting flanges built into the cabinet on each side. An optional bottom mounting bracket (purchased separately) is available, but not required.

The unit itself is suitable for 0" clearance, but the supply air flange requires a minimum of 1/4" clearance to combustible material. However, it is generally recommended that a 1" clearance is used for ease of installation and maintaining the required clearance to combustible material. See Figure 8 for details on opening sizes.

**IMPORTANT:** *When removing the shipping pallet from beneath the wall unit, **do not** loosen or remove any of the screws from either side of the unit.*

1. Locate and mark lag bolt locations on both sides and location for optional bottom mounting bracket, if desired (see Figure 8).

**NOTE:** *Top rain flashing is attached to back of unit for shipping purposes. Be sure to remove this flashing before installing unit.*

2. If desired, hook top rain flashing under back bend of top.
3. Position unit in opening and secure with fasteners sufficient for the application such as 5/16" lag/anchor bolts; use 7/8" diameter flat washers on the lag bolts. It is recommended that a bead of commercial grade outdoor silicone sealant caulk be placed behind the side mounting flanges.

**NOTE:** *Opening and removing the filter access door from each side may make fastening unit to wall easier.*

4. Secure optional rain flashing to wall and caulk around entire unit (see Figure 8).
5. For additional mounting rigidity, the return air and supply air frames or collars can be drilled and screwed or welded to the structural wall itself (depending upon wall construction). Be sure to observe required clearance if combustible wall.
6. Four plastic drain hoses extend from the condenser and evaporator drain pans. The drain hoses are secured to fittings mounted to the unit base.

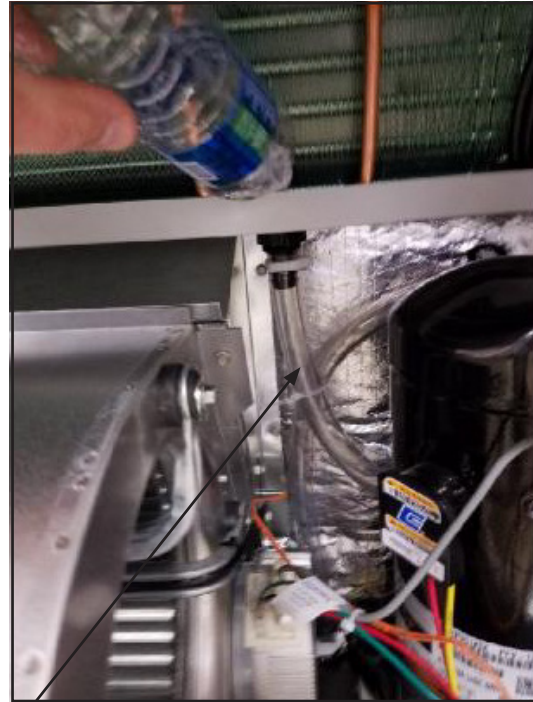
**NOTE:** *At the time of installation, Bard highly recommends prefilling of the traps on both of the indoor drain pan hoses to ensure proper unit drainage at start. The water traps can easily be seen with the front service panel removed. To fill traps, pour water into both sides of evaporator drain pan until the drain hoses are visibly full (see Figure 3).*

A unique feature of the FUSION-TEC WR Series wall-mount unit is the ability to hang the front service panel on the unit in a position that allows full access to the control panel (see Figure 4) while the unit remains fully functional for troubleshooting and testing. To do this, remove the panel and hook top lip of panel into bottom channel of control panel. For added front panel stability, use several of the screws that were removed to temporarily connect the panel to the unit.

**FIGURE 3**  
Prefilling Traps on Indoor Drain Pan Hoses



Evaporator Drain Pan Left Side Drain Hose



Evaporator Drain Pan Right Side Drain Hose

Pour water into evaporator drain pan directly above left and right drain fittings until coiled drain tubes in blower section are visibly full.

**FIGURE 4**  
Hanging Front Access Panel to Allow  
Access to Control Panel



## Supply Air Grill Installation

Bard model SGR-5W grille is custom designed for utilization with Bard wall-mount unit WR\*\*BP\* for optimizing the air flow pattern and distribution to minimize recirculation issues, and optimizing airflow patterns within the shelter. It is engineered to ensure that the distributed air is forced in a downward and outward direction to eliminate obstructions and such from causing the distributed air from stratifying close to the unit and getting drawn back into the return air opening. With the optimized air pattern, the shelter should experience distributed air at the opposite end of the room.

To accomplish this, the grille has two special features:

1. The grille has a specialty fold-out diverter on the backside of the grille that directs the supply airflow in an outward pattern, thereby eliminating the potential for the obstruction of supply air if

**FIGURE 5**  
Fold-Out Diverter



equipment would be directly mounted in front of the unit. The rear deflectors must be folded out and secured by the installer with the supplied screws (see Figure 5).

2. The grille is also equipped with downward curved diverter blades to ensure a smooth and efficient means of directing the air pattern in a downward pattern, and away from being drawn back into the return air opening. The curved diverter blades are shipped in the flat position and need to be folded out to between 75-90° (best tuned to each individual structure). See Figures 6 and 7.

**FIGURE 6**  
Downward Curved Diverter Blades

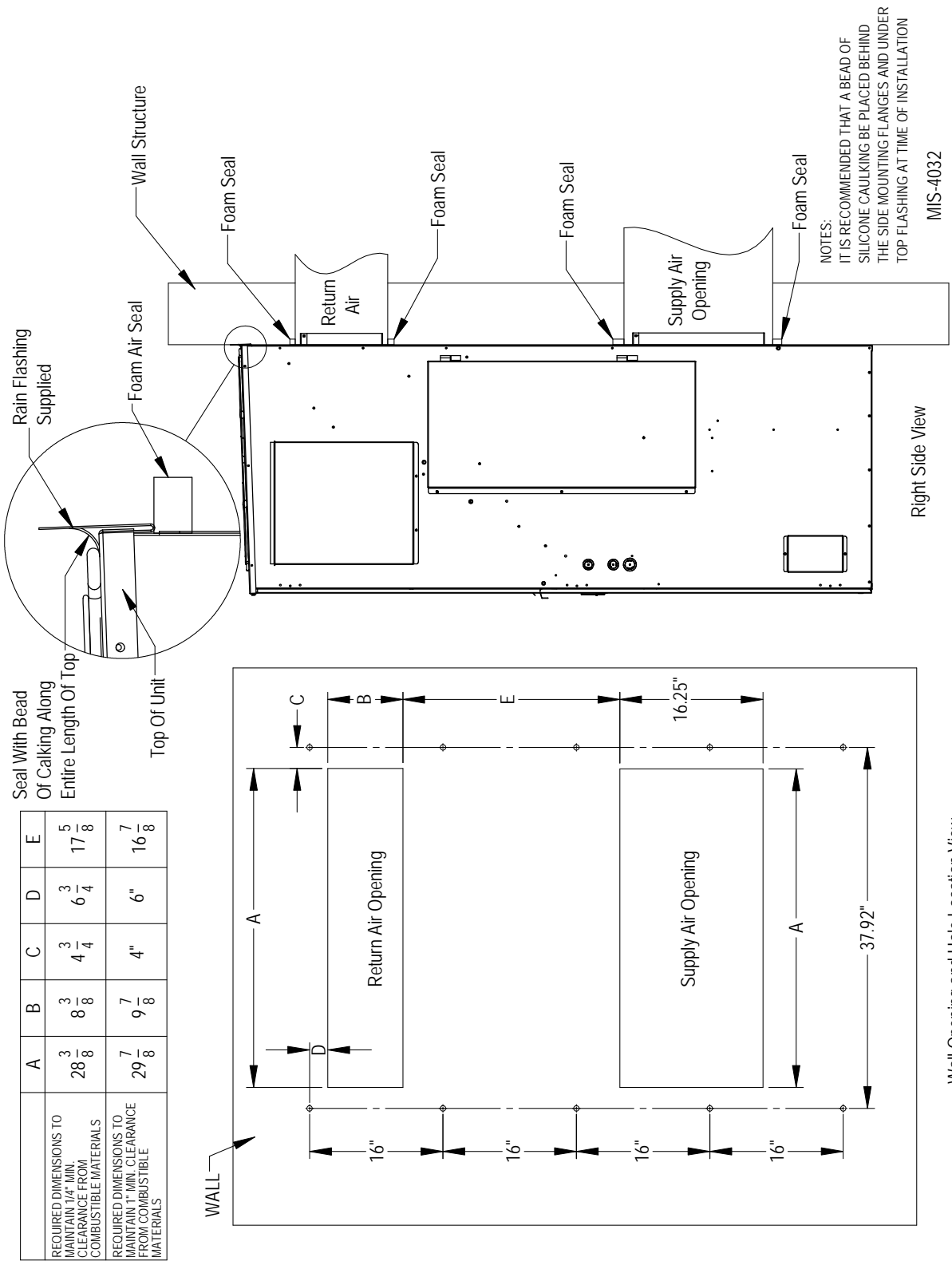


Diverter blades as shipped (left), and after raising (right)

**FIGURE 7**  
View of Installed Grille (as seen from above)



**FIGURE 8**  
**WR35 Mounting Instructions**



Seal With Bead  
Of Caulking Along  
Entire Length Of Top  
Top Of Unit

	A	B	C	D	E
REQUIRED DIMENSIONS TO MAINTAIN 1/4" MIN. CLEARANCE FROM COMBUSTIBLE MATERIALS	$28 \frac{3}{8}$	$8 \frac{3}{8}$	$4 \frac{3}{4}$	$3 \frac{3}{4}$	$17 \frac{5}{8}$
REQUIRED DIMENSIONS TO MAINTAIN 1" MIN. CLEARANCE FROM COMBUSTIBLE MATERIALS	$29 \frac{7}{8}$	$9 \frac{7}{8}$	4"	6"	$16 \frac{7}{8}$

NOTES:  
IT IS RECOMMENDED THAT A BEAD OF SILICONE CAULKING BE PLACED BEHIND THE SIDE MOUNTING FLANGES AND UNDER TOP FLASHING AT TIME OF INSTALLATION

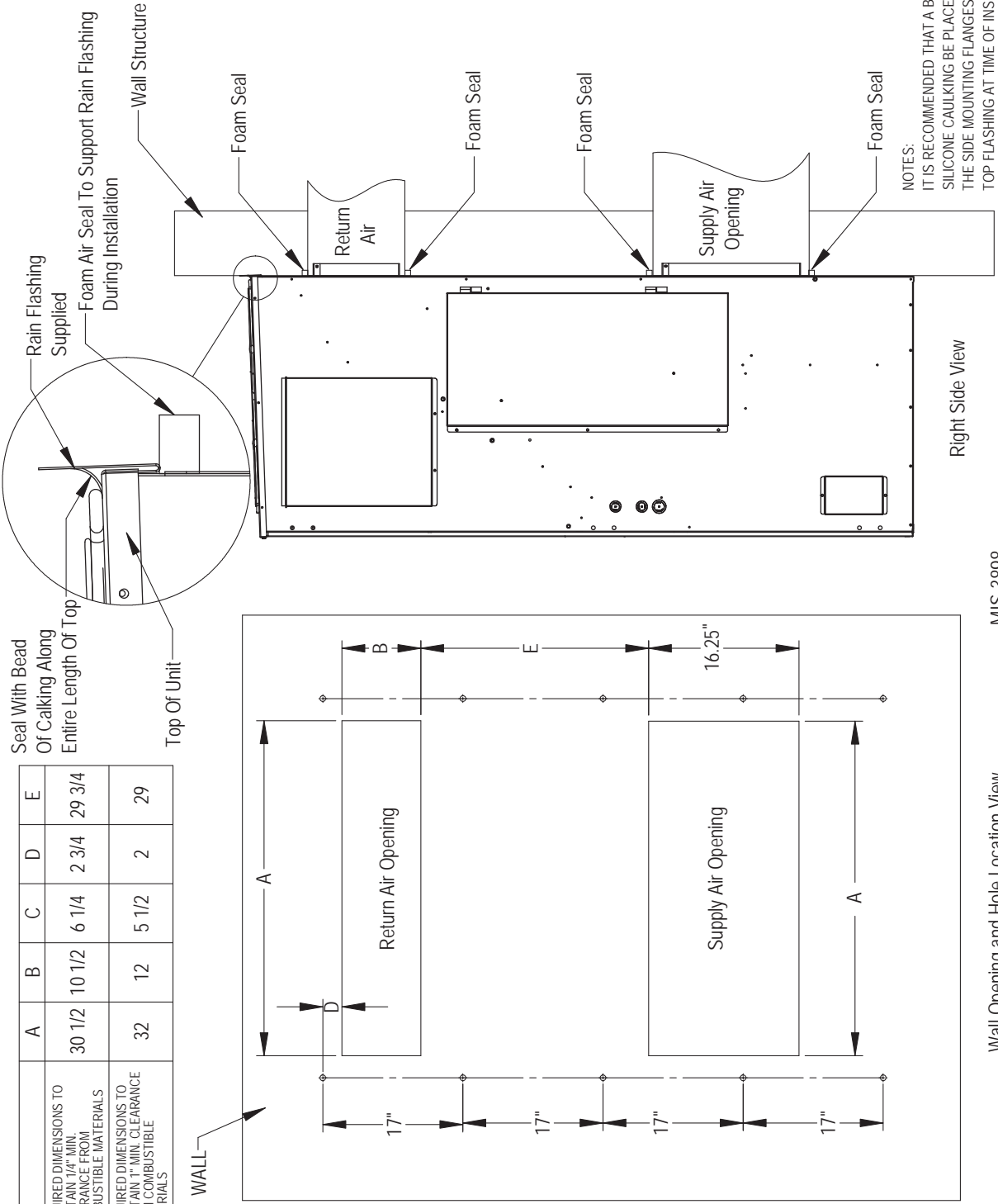
MIS-4032

Wall Opening and Hole Location View



**FIGURE 9**  
**WR36/WR58 Mounting Instructions**

	A	B	C	D	E
REQUIRED DIMENSIONS TO MAINTAIN 1/4" MIN. CLEARANCE FROM COMBUSTIBLE MATERIALS	30 1/2	10 1/2	6 1/4	2 3/4	29 3/4
REQUIRED DIMENSIONS TO MAINTAIN 1" MIN. CLEARANCE FROM COMBUSTIBLE MATERIALS	32	12	5 1/2	2	29



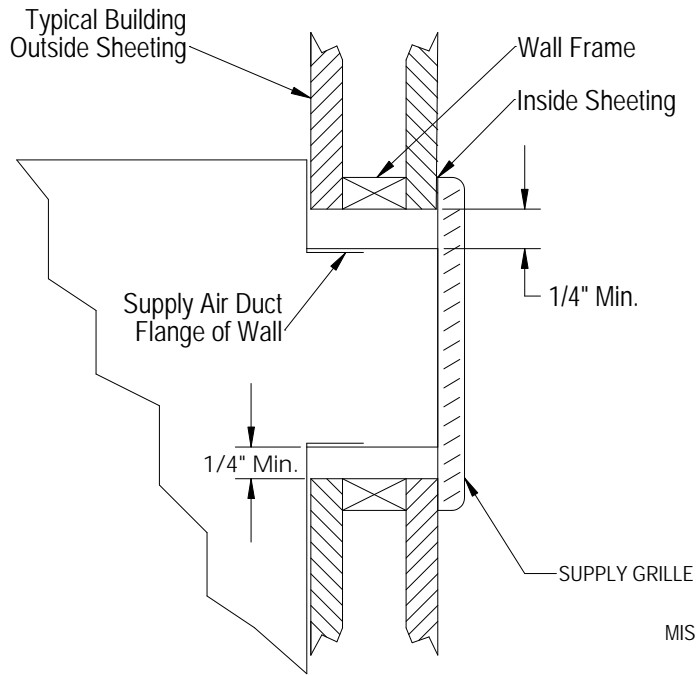
NOTES:  
IT IS RECOMMENDED THAT A BEAD OF SILICONE CAULKING BE PLACED BEHIND THE SIDE MOUNTING FLANGES AND UNDER TOP FLASHING AT TIME OF INSTALLATION

MIS-3898

Wall Opening and Hole Location View

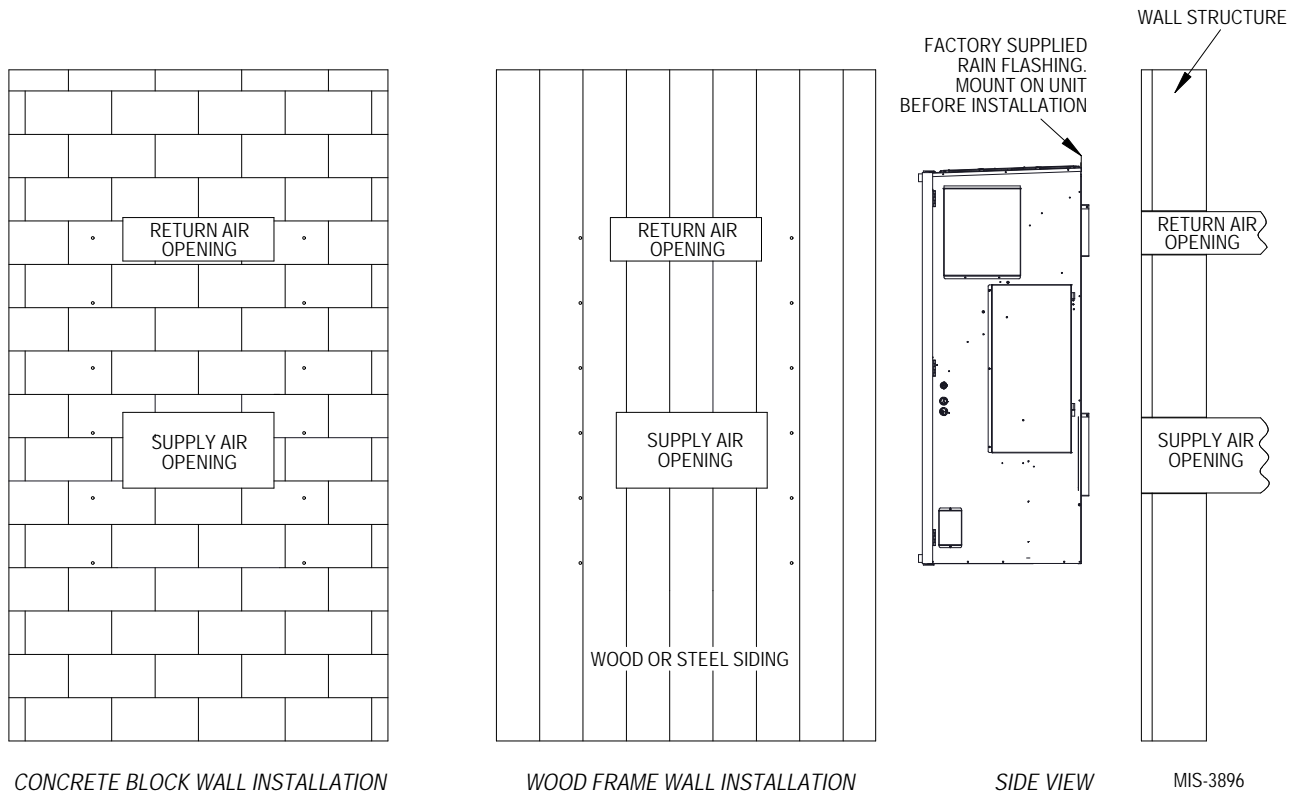


**FIGURE 10**  
**Electric Heat Clearance**



MIS-3897

**FIGURE 11**  
**Wall Mounting Instructions**



CONCRETE BLOCK WALL INSTALLATION

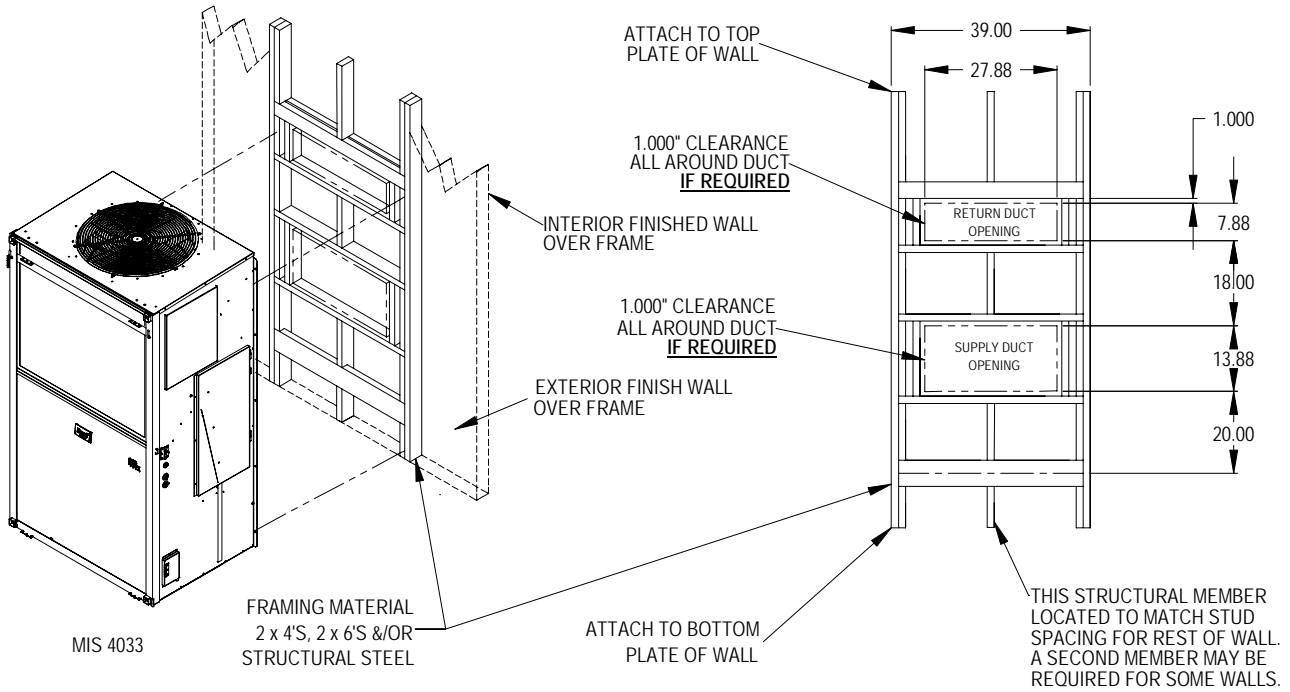
WOOD FRAME WALL INSTALLATION

SIDE VIEW

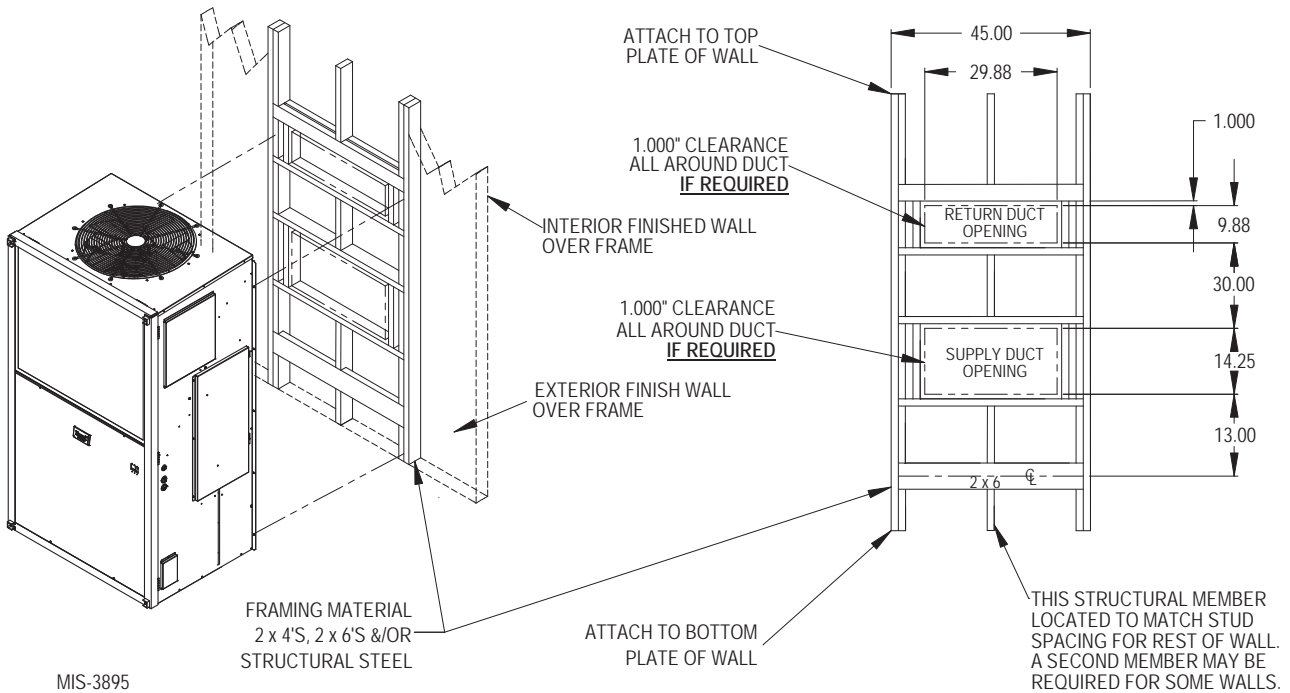
MIS-3896

**FIGURE 12**  
**Wall Mounting Instructions**

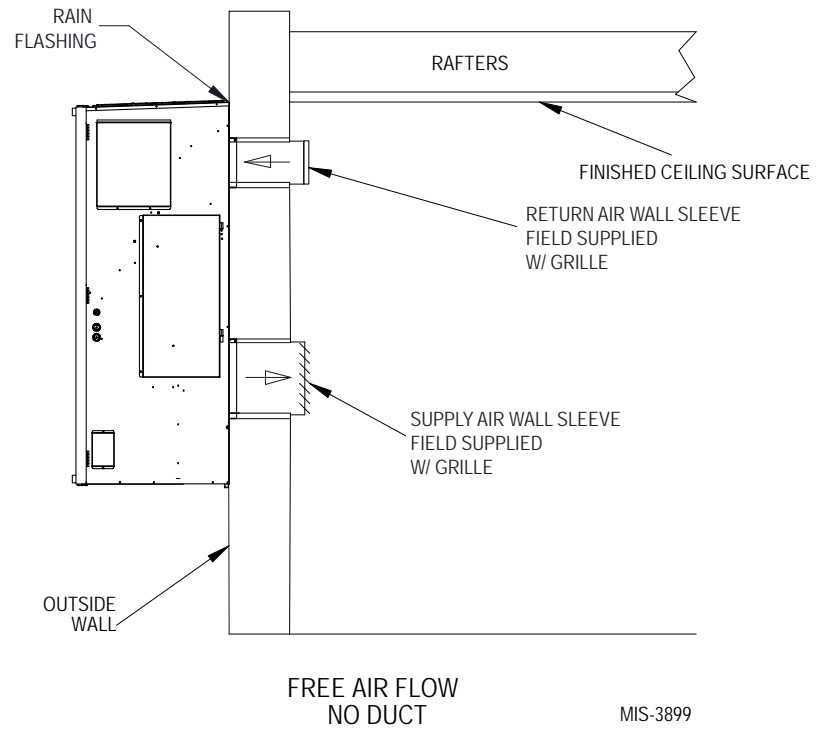
**WR35 Models**



**WR36/WR58 Models**



**FIGURE 13**  
**Common Wall Mounting Installation**



# WALL-MOUNT UNIT WIRING

## WARNING

**Electrical shock hazard.**

**Have a properly trained individual perform these tasks.**

**Failure to do so could result in electric shock or death.**

### Main Power Wiring

Refer to the unit rating plate or Table 3 for wire sizing information and maximum fuse or circuit breaker size. Each outdoor unit is marked with a “Minimum Circuit Ampacity”. The field wiring used must be sized to carry that amount of current. Depending on the installed KW of electric heat, there may be two field power circuits

required. If this is the case, the unit rating plate will so indicate. All models are suitable only for connection with copper wire. Each unit and/or wiring diagram will be marked “Use Copper Conductors Only”. These instructions **must be** adhered to. Refer to the National Electrical Code (NEC) for complete current carrying capacity data on the various insulation grades of wiring material. All wiring must conform to NEC and all local codes.

The unit rating plate and Table 3 list fuse and wire sizes (75°C copper) for all models including the most commonly used heater sizes. Also shown are the number of field power circuits required for the various models with heaters.

The unit rating plate lists a maximum circuit breaker or fuse that is to be used with the equipment. The correct size must be used for proper circuit protection and also to ensure that there will be no nuisance tripping due to the momentary high starting current of the compressor motor.

**TABLE 3**  
**Electrical Specifications**

Model	Rated Volts & Phase	No. Field Power Circuits	Single Circuit			
			③ Minimum Circuit Ampacity	① Maximum External Fuse or Circuit Breaker	② Field Power Wire Size	② Ground Wire
WR35 A0Z, AMZ A01, AM1 A05, AM5	230/208-1	1	26	35	8	10
		1	26	35	8	10
		1	30	35	8	10
HR35 B0Z B05	230/208-3	1	25	30	10	10
		1	25	30	10	10
WR36 A0Z, AMZ A01, AM1 A05, AM5	230/208-1	1	26	35	8	10
		1	26	35	8	10
		1	30	35	8	10
HR36 B0Z B05	230/208-3	1	25	30	10	10
		1	25	30	10	10
WR58 A0Z, AMZ A01, AM1 A05, AM5	230/208-1	1	43	60	8	10
		1	43	60	8	10
		1	43	60	8	10
HR58 B0Z B05	230/208-3	1	30	45	8	10
		1	30	45	8	10

① Maximum size of the time delay fuse or circuit breaker for protection of field wiring conductors.

② Based on 75°C copper wire. All wiring must conform to the National Electrical Code and all local codes.

③ These “Minimum Circuit Ampacity” values are to be used for sizing the field power conductors. Refer to the National Electrical code (latest version), Article 310 for power conductor sizing.

**CAUTION:** When more than one field power circuit is run through one conduit, the conductors must be derated. Pay special attention to Note 8 of Table 310 regarding Ampacity Adjustment Factors when more than three current carrying conductors are in a raceway.

**IMPORTANT:** While this electrical data is presented as a guide, it is important to electrically connect properly sized fuses and conductor wires in accordance with the National Electrical Code and all local codes.

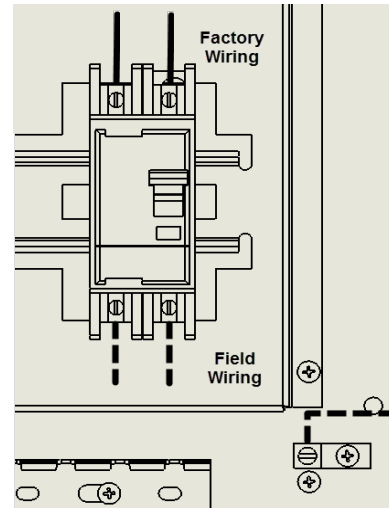
The main unit circuit breaker disconnect access is located on the front panel of the unit. Located at the upper right corner of this panel is the rubber circuit breaker boot. This allows unit power to be disconnected without panel removal.

Route all field power wires in channel under the control panel as shown in Figure 14. See Figure 15 to reference VAC landing points.

**FIGURE 14**  
**Wire Routing**



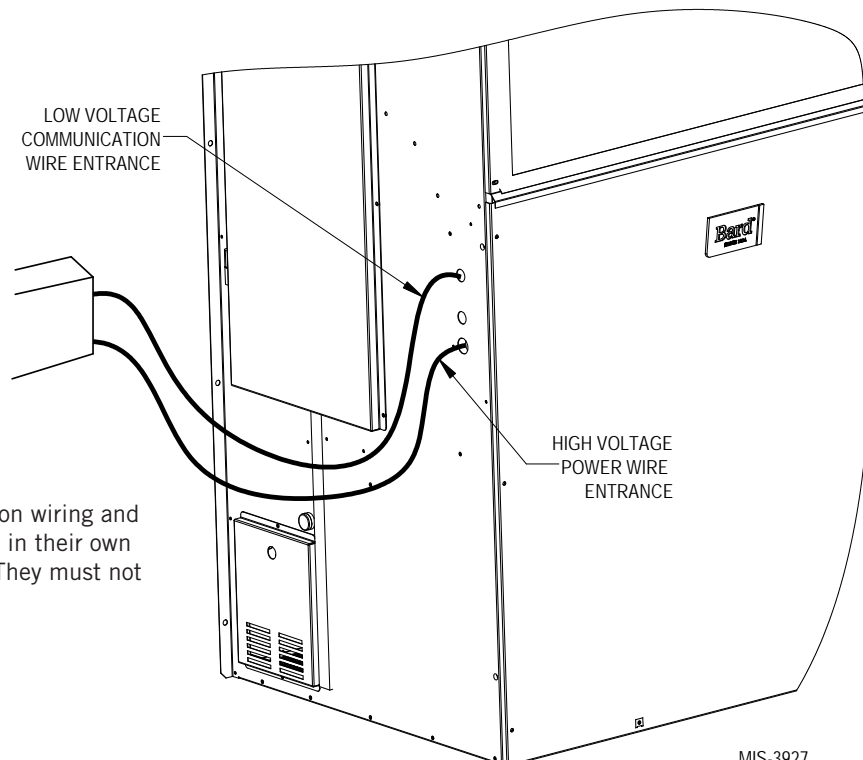
**FIGURE 15**  
**VAC Supply Wiring Landing Points**



Route wires into unit through recommended side entrances (see Figure 16). Optional rear entry points are also available (see Figure 17 on page 20).

When running wires to unit from shelter, be careful to not place wiring and conduit where it will interfere with opening filter access doors.

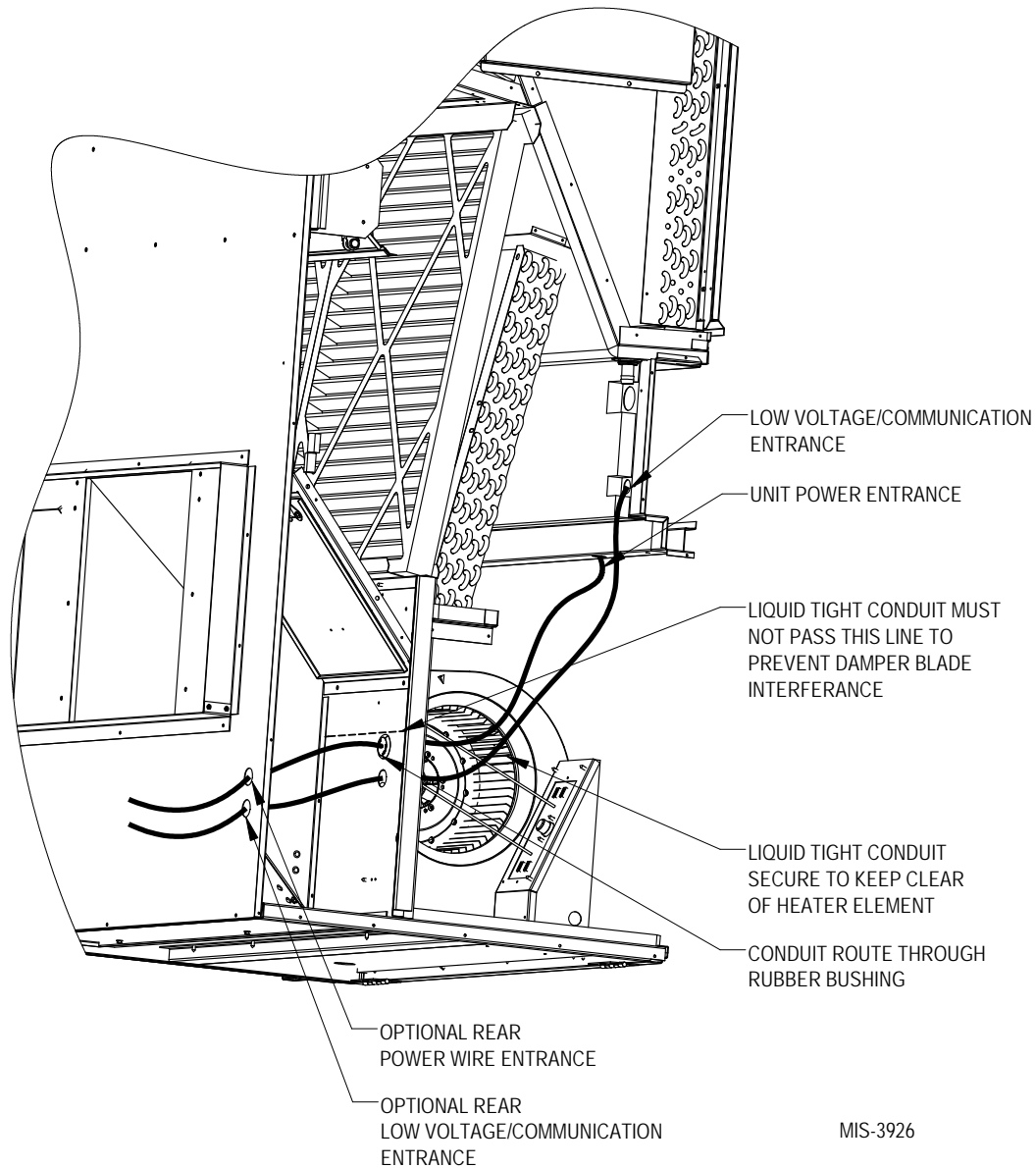
**FIGURE 16**  
**Side Communication and Power Wire Entrances (Recommended)**



Route communication wiring and power supply wiring in their own separate conduits. They must not be run together.

MIS-3927

**FIGURE 17**  
**Rear Communication and Power Wire Entrances (Optional)**



MIS-3926

### **Unit Control Voltage Wiring**

230/208V 1 phase and 3 phase equipment use dual primary voltage transformers. All equipment leaves the factory wired on 240V tap. **It is very important that the correct voltage tap is used.** For 208V operation, reconnect from 240V to 208V tap. The acceptable operating voltage range for the 240 and 208V taps are: 240V tap (253 – 216) and 208 tap (220 – 197). To verify voltage and adjust voltage tap (if necessary), see Figure 18.

**NOTE:** *The voltage should be measured at the field power connection point in the unit and while the unit is operating at full load (maximum amperage operating condition).*



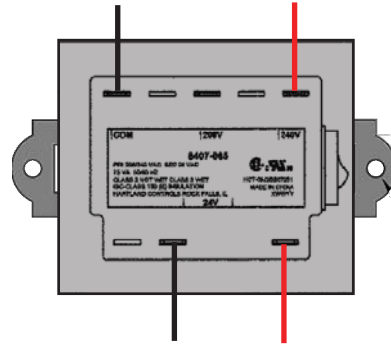
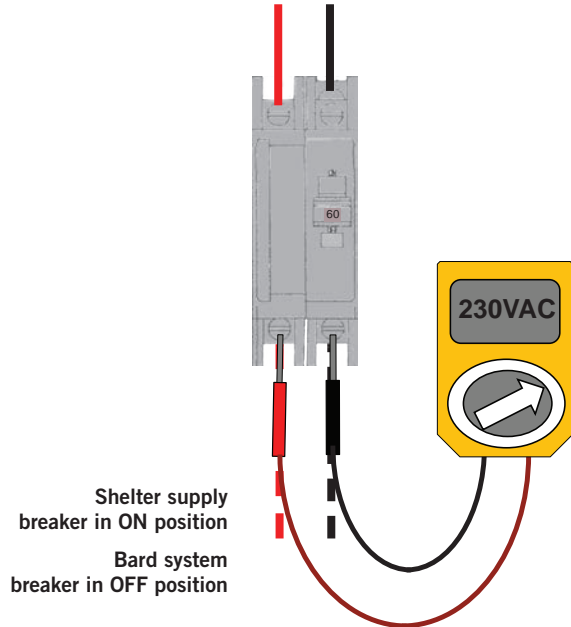
**FIGURE 18**  
**Adjusting the 230/208 VAC Transformer**

230/208V 1 phase and 3 phase equipment use dual primary voltage transformers. All equipment leaves the factory wired on 240V tap. **It is very important that the correct voltage tap is used.** For 208V operation, reconnect from 240V to 208V tap. The acceptable operating voltage range for the 240 and 208V taps are: 240V Tap (253 – 216) and 208 Tap (220 – 197).

1. Verify incoming AC voltage: Multimeter set to VAC

2. If incoming AC voltage is 220VAC or above...

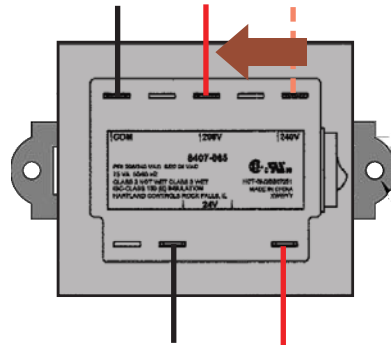
...do not adjust transformer



3. If incoming AC voltage is below 220VAC...

...shut off AC breaker to unit

and move factory "240V" wire to "208V" terminal



240V/208V Single Phase Voltage Range:  
197VAC – 253VAC

240V/208V Three Phase Voltage Range:  
197VAC – 253VAC  
(not shown)

# PRELIMINARY START UP

---

## Running in Orphan Mode

FUSION-TEC WR Series wall-mount units have the capability to run without the LC6000 controller attached—this feature is called orphan mode. This keeps the shelter between 60°F and 77°F (factory default settings) by the use of the factory-installed return air sensor in each wall-mount unit. In orphan mode, no auxiliary temperature measurement devices are required for operation. The wall-mount unit automatically uses a continuous blower setting to circulate room air into the return air inlet and uses the return air temperature sensor to control room temperature.

To verify or change the wall-mount unit cooling and heating setpoints in orphan mode:

1. Connect the TEC-EYE diagnostic tool to the control board located in the unit.
2. From the Status screen, press UP or DOWN key until Quick Menu displays Setpoints (Set) icon. Press ENTER key.
3. Press ENTER key to scroll to the selected choice (see Figure 19).
4. Press UP or DOWN key on desired value until value displays correctly.
5. Press ENTER key to save and scroll to next parameter.
6. Press ESCAPE key until Main Menu screen is displayed.

During installation, the ability to run in orphan mode allows deactivation of one of the existing, older wall-mount units, while keeping the shelter cool with the other unit still operating. Once the first of the Bard FUSION-TEC WR Series wall-mount units is installed and powered on, it will operate in orphan mode—keeping the climate inside the shelter stable and the installers comfortable while the remainder of the older equipment is removed and the remaining Bard FUSION-TEC WR Series wall-mount units and LC6000 controller are installed.

Additionally, should any or all of the FUSION-TEC WR Series wall-mount units lose communication with the LC6000 controller (such as during maintenance), they will continue to serve the shelter's needs until a repair can be made.

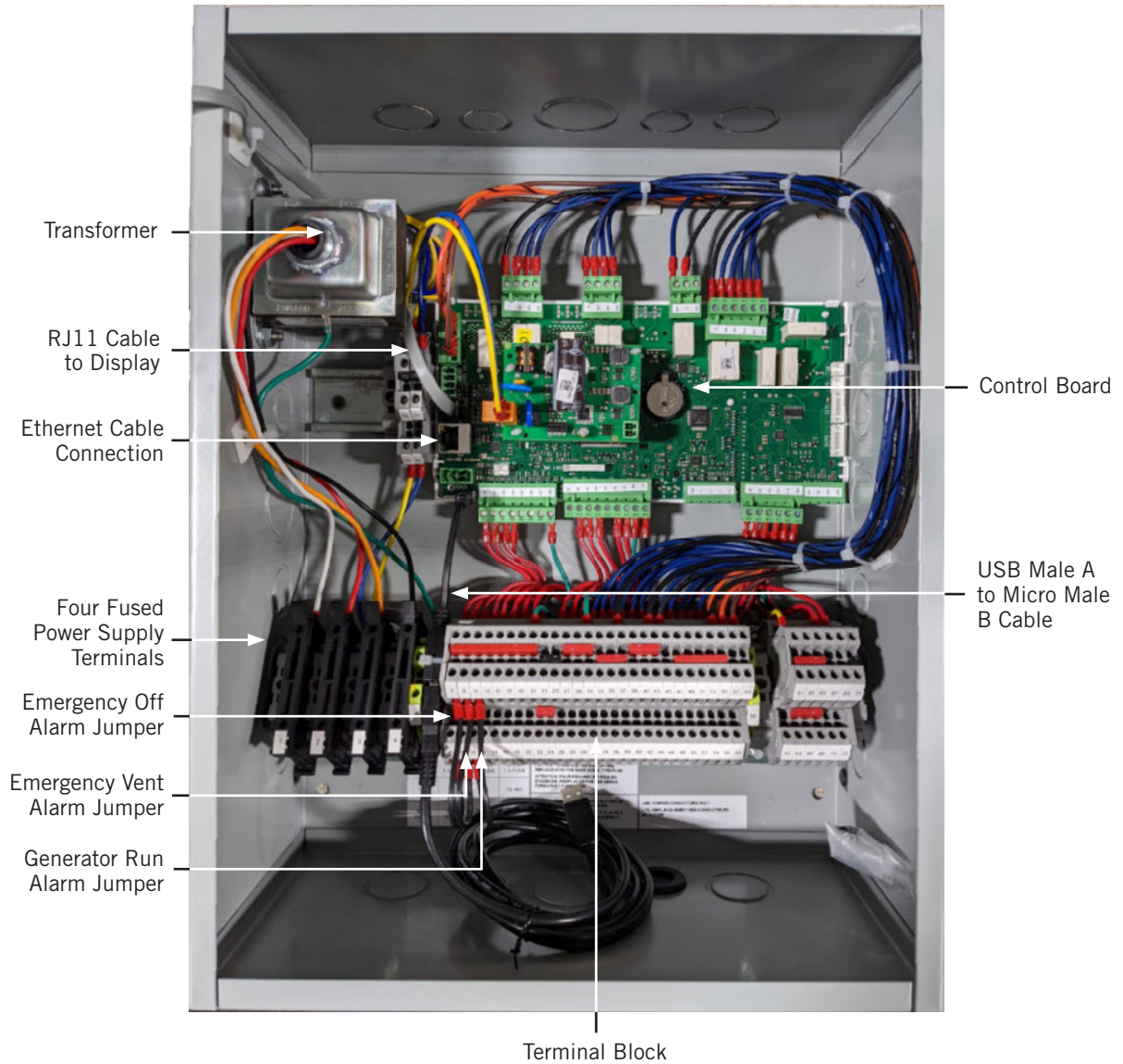
**NOTE:** Screenshots shown in this manual reflect default settings (when applicable).

FIGURE 19  
Cool and Heat Setpoints



# LC6000 CONTROLLER INSTALLATION

FIGURE 20  
Typical LC6000-200 Component Location



# **WARNING**

**Electrical shock hazard.**

**Disconnect VAC power supplies before servicing.**

**Failure to do so could result in electric shock or death.**

**IMPORTANT:** When working with circuit board components, Bard recommends the use of an anti-static wrist strap to prevent static electricity shorts to electronic controls.

## **LC6000 Controller**

The LC6000 controller is part of this air conditioning system. It is used to control up to 14 wall-mount air conditioners from one controller. The microprocessor control provides an easy-to-read interface with large LCD graphical display. It provides control for redundancy for the structure and equal wear on all units.

**Conduit is recommended for all wiring. Route communication wiring and power supply wiring in their own separate conduits.**

**The LC6000 controller is not weatherproof and is intended for use in a weathertight structure.**

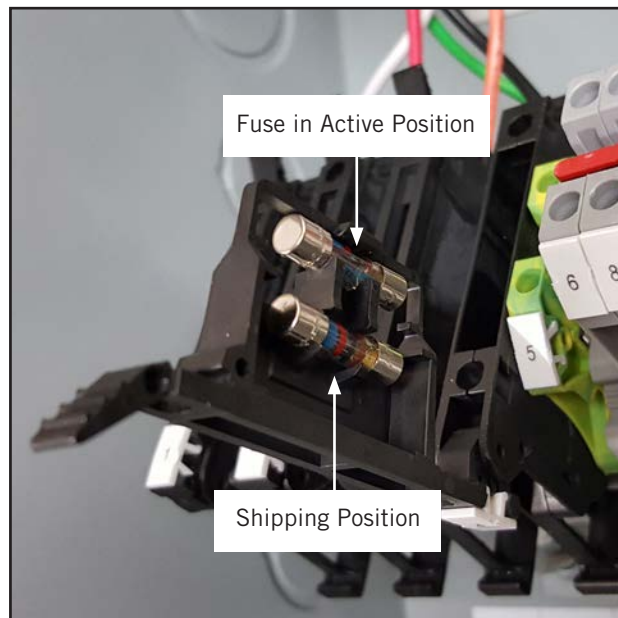
## **Mounting the LC6000 Controller**

The dimensions of the LC controller are 16" x 12" x 6".

Because the LC6000 controller utilizes a remote temperature sensor as opposed to one located in the controller box, the controller itself can be installed in any indoor location that is suitable, preferably at eye level. Four (4) mounting holes are provided for mounting to the wall and holes for conduit connections are provided in the base, sides and top of the controller.

The LC6000 controller includes four fused power supply terminals in the terminal block. Before connecting wires to the terminal block, confirm that the fuse in each of the four fuse holders is in the proper position (active) as shown in Figure 21.

**FIGURE 21**  
**LC6000 Fused Power Supply Terminals**



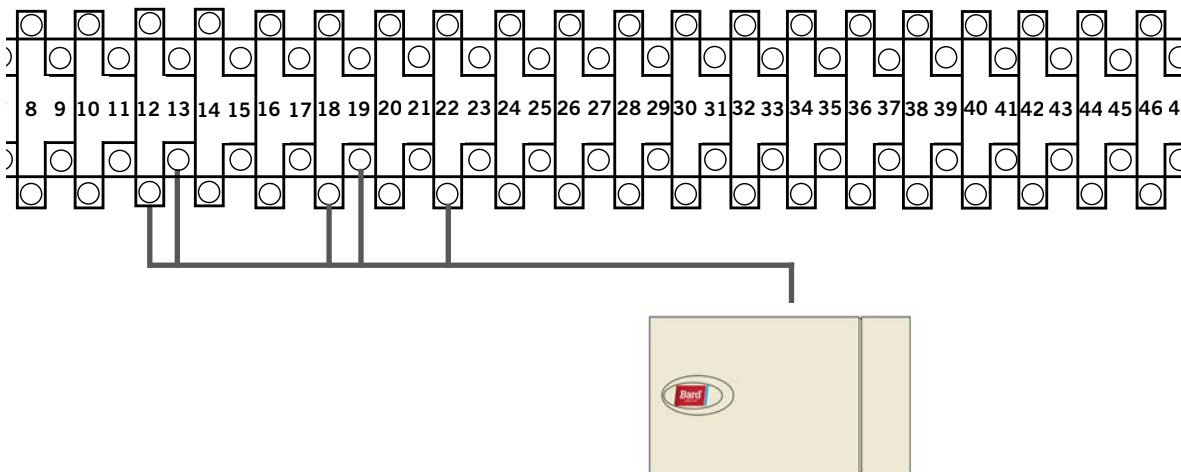
## Installing Remote Indoor Temperature/Humidity Sensor(s)

One remote indoor temperature/humidity sensor and 35' of 18 gauge 5-conductor shielded cable is included with the controller. This sensor must be installed for proper operation. Mount the temperature/humidity sensor in a location least likely to be affected by open doors, rack-mounted fans, radiant heat sources, etc. Locating the sensor between both return grilles is often the best location, but every installation is unique. Location height should be approximately 60" above the floor. The sensor should be installed on a 2" x 4" junction box to allow for control wire conduit. Use shielded cable to connect to controller.

**FIGURE 22**  
**Remote Indoor Temperature/Humidity Sensor Installation**

1. Connect wires from the 18 gauge shielded cable to terminals #12, #13, #18, #19 and #22.

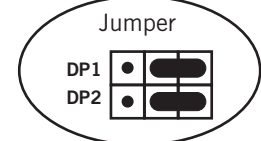
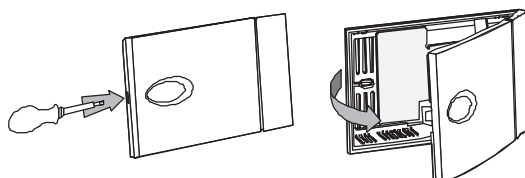
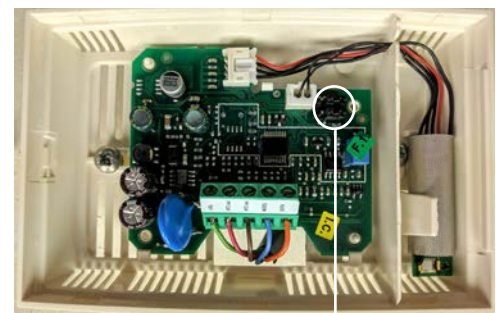
TB#	Wire Mark	Sensor	Description
18	B6	NTC OUT	Indoor Remote Sensor (Zone 1)
19	GND	NTC OUT	Ground
12	B2	OUT H	Remote Indoor Humidity Sensor: 0-1 VDC (Zone 1)
13	GND	M (GO)	Ground
22	+VDC	+ (G)	Power for B2



2. Connect the other end of the shielded cable to the sensor terminals. Be sure wires are connected to proper terminals as shown in table above.

**Sensor jumpers need to be positioned for 0-1 V.** With sensor oriented as shown in image to right, move both jumpers to right position (DP1 and DP2 set to OFF). **This applies to all indoor temperature/humidity sensors connected to the LC controller.** See illustration mounted inside of sensor cover for further detail on jumper position.

**Earlier versions of this sensor may be mounted in a different orientation which would affect the positioning of the sensor jumpers.** See page 47 for additional information on sensor orientation.



For proper operation, the remote indoor temperature/humidity sensor (and any additional sensors) must be configured properly with the controller as shown in Step 2 on page 25. An additional remote indoor temperature-only sensor can be purchased and installed in Zone 1. If the site in which the LC6000 controller will be used has more than one zone (maximum three zones per LC6000), additional remote temperature/humidity sensors (one per zone) will need to be purchased and installed in the additional zones. All installed sensors must be enabled in the controller menu (see **Configure Sensors** beginning on page 40).

**FIGURE 23**  
**Additional Remote Temperature and Temperature/Humidity Sensor Installation**

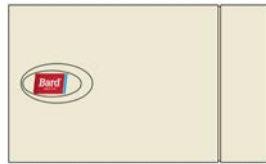
One additional temperature sensor can be added to Zone 1 and additional temperature/humidity sensors may be added to Zones 2 and 3 (one per zone). **Be sure the sensors are connected to the proper terminals on the terminal block and sensor as listed below.**



**Zone 1:**  
 Optional Remote Temperature Sensor  
**Terminals 20 & 21\***

TB#	Wire Mark	Description
20	B7	Indoor Remote Sensor (Zone 1 – optional)
21	GND	Ground

\* The two wire connections for the optional remote temperature sensor are not polarity sensitive.



**Zone 2:**  
 Optional Remote Temperature/Humidity Sensor  
**Terminals 26, 27, 14, 15 & 23**

**IMPORTANT:** Note jumper position in Figure 21

TB#	Wire Mark	Sensor	Description
26	B8	NTC OUT	Indoor Remote Sensor (Zone 2)
27	GND	NTC OUT	Ground
14	B3	OUT H	Remote Indoor Humidity Sensor: 0-1 VDC (Zone 2)
15	GND	M (GO)	Ground
23	+VDC	+ (G)	Power for B3



**Zone 3:**  
 Optional Remote Temperature/Humidity Sensor  
**Terminals 28, 29, 16, 17 & 24**

**IMPORTANT:** Note jumper position in Figure 21

TB#	Wire Mark	Sensor	Description
28	B9	NTC OUT	Indoor Remote Sensor (Zone 3)
29	GND	NTC OUT	Ground
16	B4	OUT H	Remote Indoor Humidity Sensor: 0-1 VDC (Zone 3)
17	GND	M (GO)	Ground
24	+VDC	+ (G)	Power for B4

Zones 2 and 3 can also use temperature-only sensors in place of the temperature/humidity sensors. Zone 2 will connect to TB# 26 and 27. Zone 3 will connect to TB# 28 and 29. The wire connections for the temperature-only sensors are not polarity sensitive.



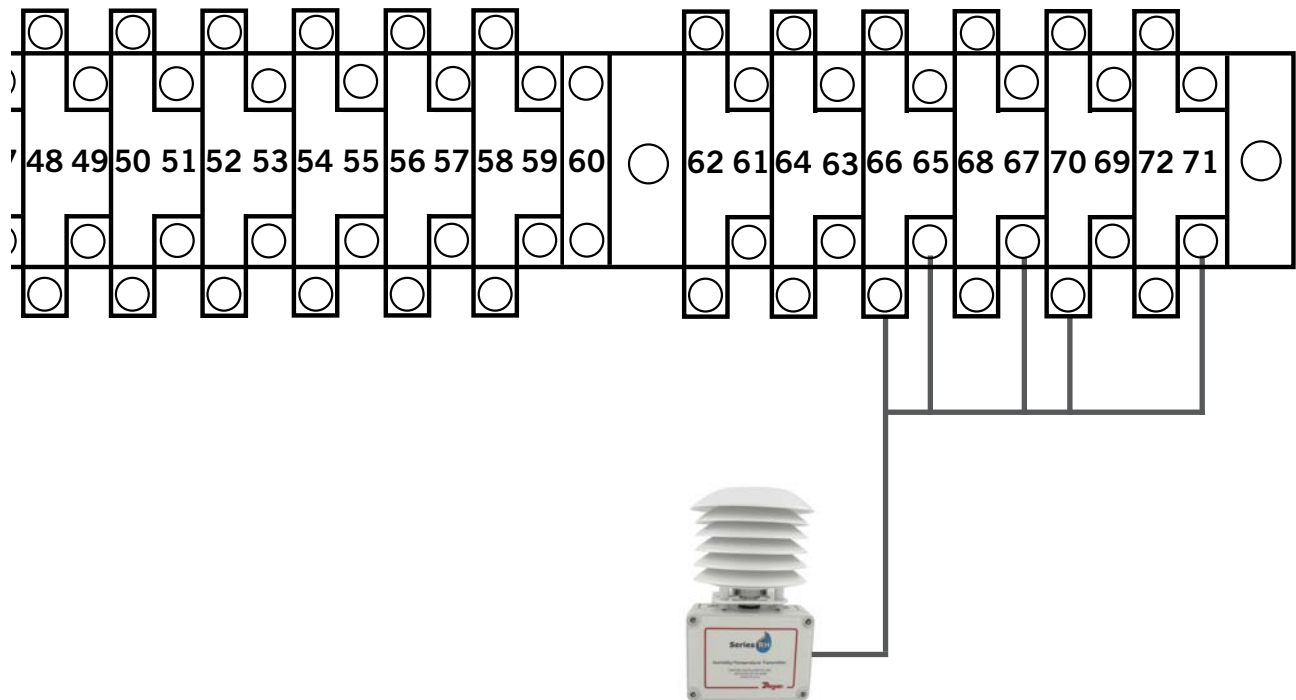
### Installing Optional Outdoor Temperature/Humidity Sensor

One optional outdoor temperature/humidity sensor (8301-090) can be installed. Follow the manufacturer's mounting instructions. Use 18 gauge 5-conductor shielded cable to connect to controller.

**FIGURE 24**  
**Remote Outdoor Temperature/Humidity Sensor Installation**

1. Connect wires from the 18 gauge shielded cable to terminals #65, #66, #67, #70 and #71.

TB#	Wire Mark	Sensor	Description
70	B12	4	Remote Outdoor Temperature Sensor
71	ND	5	Ground
67	B11	1	Remote Outdoor Humidity Sensor: 0-10 VDC
66	GND	3	Ground
65	+VDC	2	+VDC



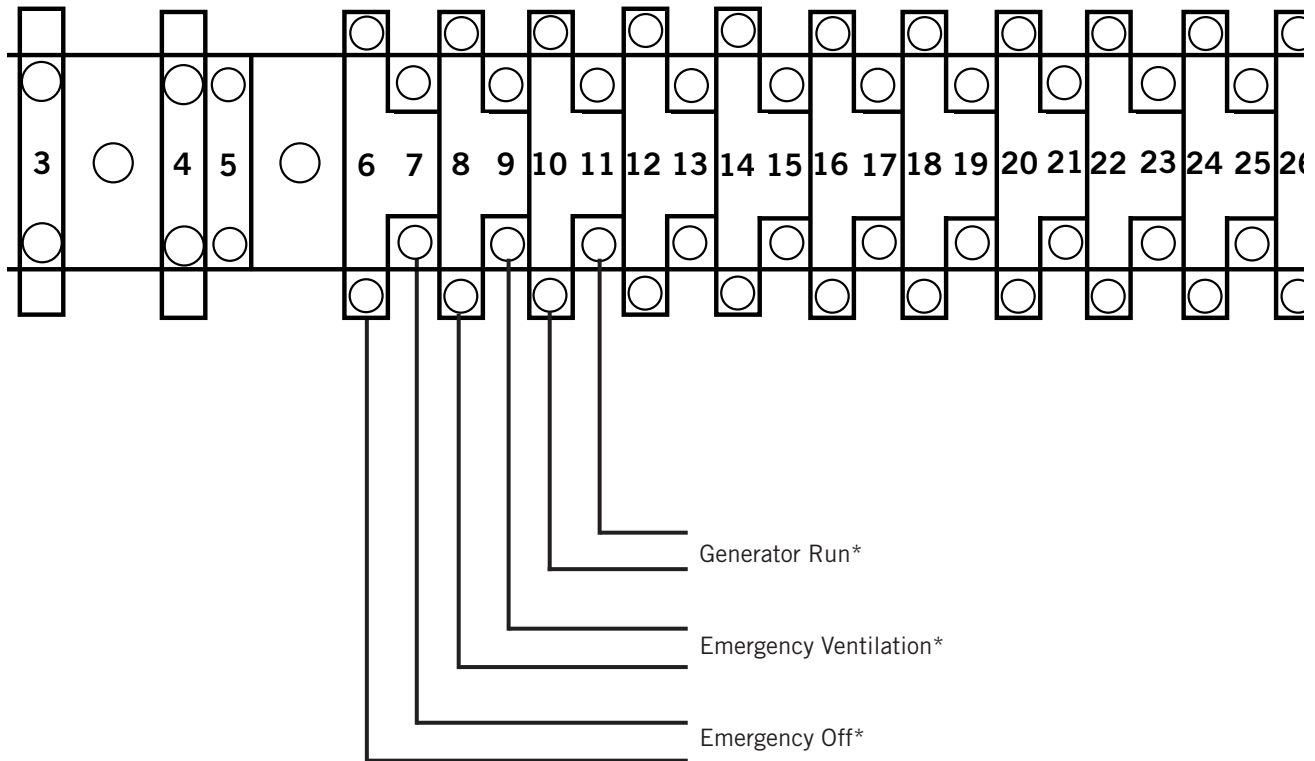
2. Connect the other end of the shielded cable to the sensor terminals. Be sure wires are connected to proper terminals as shown in table above.

### Emergency Off, Emergency Ventilation and Generator Run Connections

The LC6000-200 controller is shipped with emergency off, emergency ventilation and generator run contacts. There are factory-installed jumpers across terminals #6 and #7 (emergency off), #8 and #9 (emergency ventilation) and #10 and #11 (generator run). Remove the factory-installed jumpers before making the connections.

**FIGURE 25**

**LC6000-200 Series Connection for Emergency Off, Emergency Ventilation and Generator Run (If Applicable)**



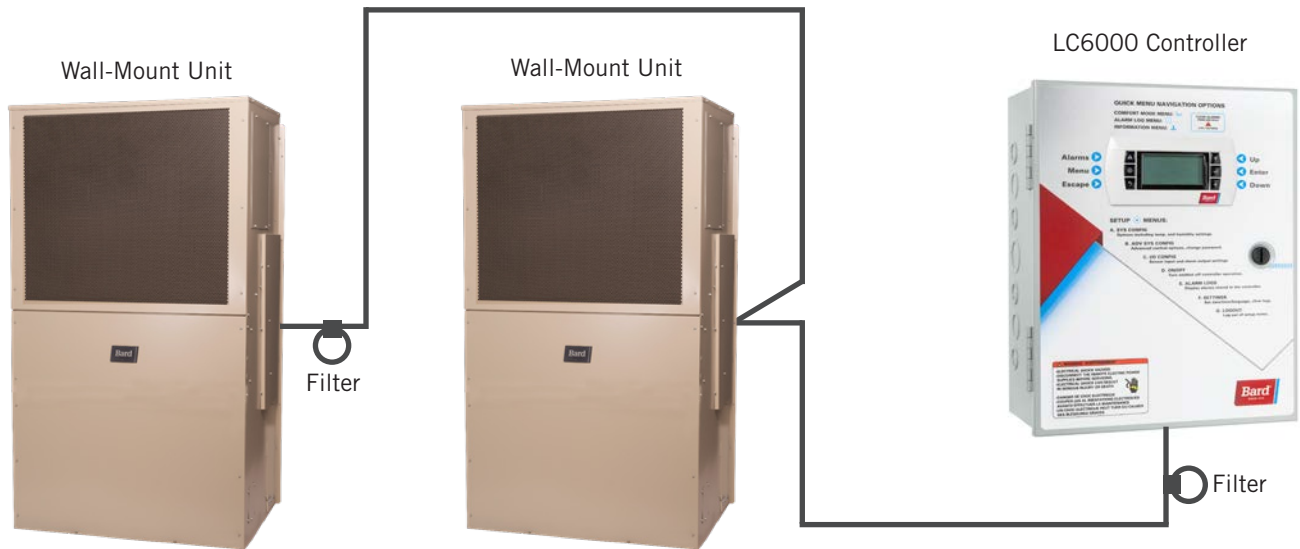
\* Normally closed (NC) contacts required.

By default:  
 Closed = No Alarm  
 Open = Alarm

## Communication Wiring

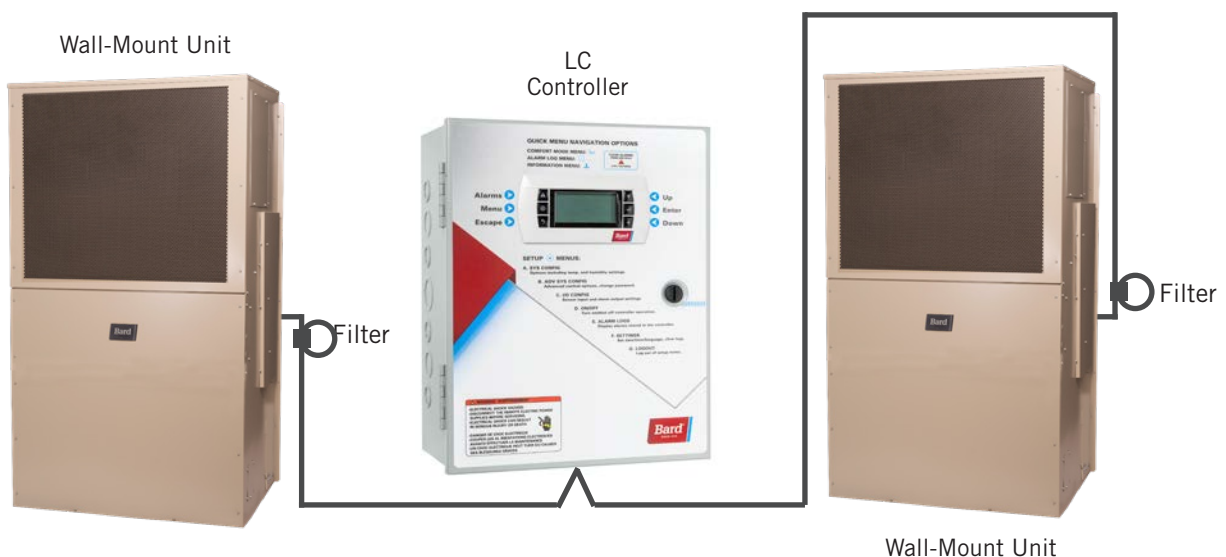
Connect the communication wiring from the wall-mount units to the controller in the manner shown in Figures 26, 27 or 28. **The daisy chain does not need to follow the addressing order.** The communication wire should be 2-wire, 18 gauge shielded cable with drain. Any color can be used. Be sure to match "+" and "-" symbols on controller terminal blocks to unit control terminal block (see Figures 30 and 31 on pages 32 and 33). Attach communication wire filters as shown in Figures 26, 27 or 28. Filters go inside the unit or controller box; they are shown out of unit for identification purposes only. **Do not run communication wiring in same conduit as supply wiring. Route communication wiring and power supply wiring in their own separate conduits.**

**FIGURE 26**  
**Communication Wiring (Daisy Chain Method)**



In addition to the "daisy chain" method of connecting the communication wiring shown in Figure 26, the wall-mount units can also be connected in the manner shown in Figure 27. If connecting wall-units this way, be sure to place the communication wire filters in the positions shown in Figure 27. See Figure 2 on page 30 for more information on the correct placement of the communication wire filters depending on the wiring method used.

**FIGURE 27**  
**Communication Wiring (Alternate Method)**



**FIGURE 28**  
**Placement of Communication Wire Filters (Daisy Chain and Alternate Methods)**

**Daisy Chain Wiring (up to 14 units)**



**Alternate Wiring (up to 14 units)**

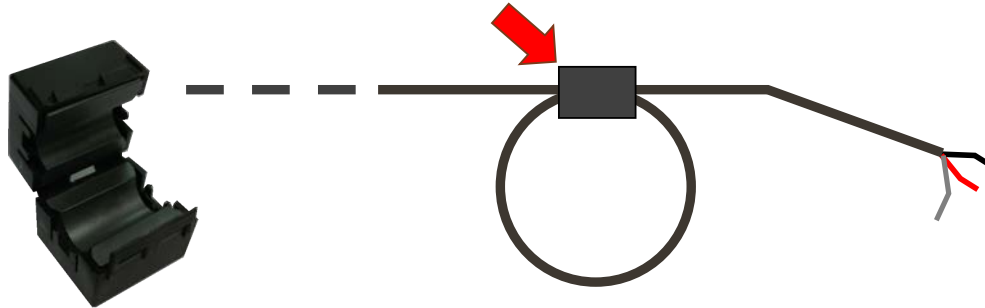


**NOTE:** Line filters can be on either the unit or controller, whichever device is on the end of the chain. No matter how many units there are, the two end devices will only have ONE communication cable, whereas the center devices will all have TWO (as shown above). Maximum two wires in each terminal. Filters go inside the unit or controller; shown out of unit above for identification only.

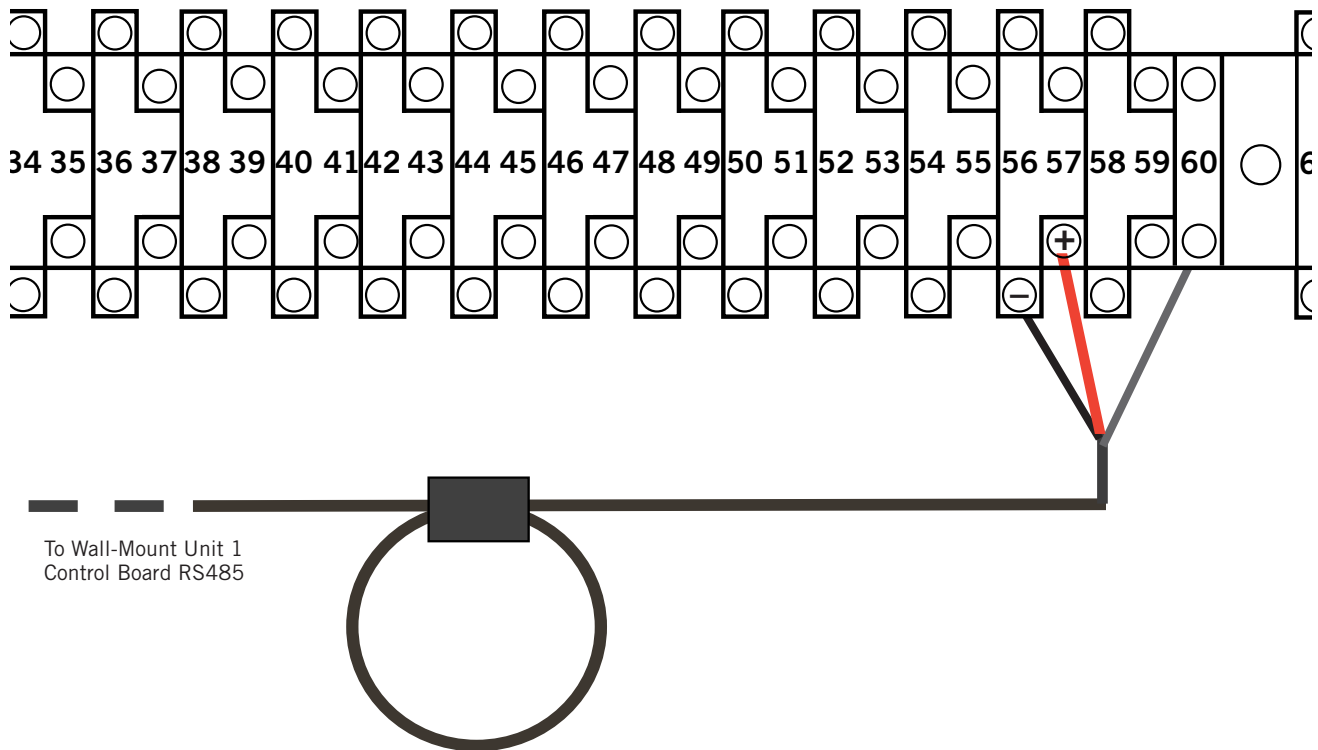
The steps outlined on the following pages show how to connect the communication wiring using the daisy chain method shown in Figure 26 on page 29. If using the alternate method (as shown in Figure 27 on page 29), the connections to the controller and each wall-mount unit will be the same but the filters need to be placed in the positions shown in Figure 28.

**FIGURE 29**  
**Communication Wiring: Termination at the Controller**

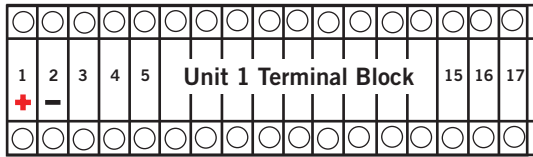
1. Using the field-provided shielded cable, make a small service loop after entering the controller and attach the provided EMI filter at the intersection of the loop.



2. Connect one wire to terminal #56 (negative), the other wire to terminal #57 (positive) and the drain wire to ground terminal #60.



**FIGURE 30**  
**Communication Wiring: Termination at the First Wall-Mount Unit**



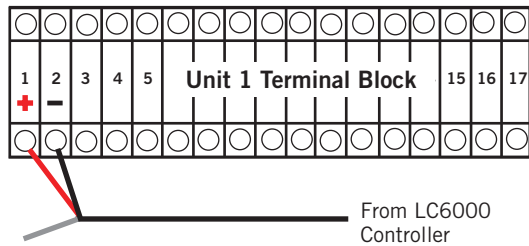
1. From the controller, extend the shielded cable through a separate conduit and route to the provided terminal block next to the wall-mount control board.

These connections are polarity-sensitive. Two-wire communication from control board is prewired to terminal block. Make sure to match "+" and "-" symbols on controller terminal block.

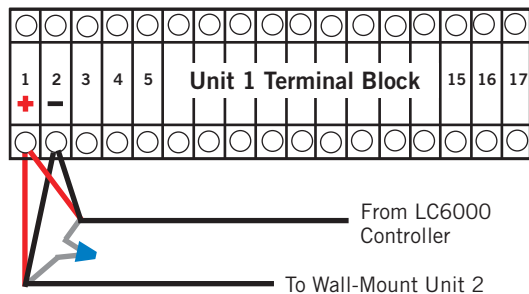


Wall-Mount Unit 1

2. Connect the wires matching the terminal designations (+/-) of the controller terminals. Leave the drain wire loose.

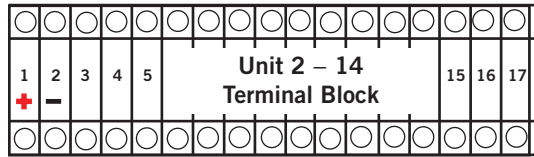


3. Connect another cable in a similar fashion ("daisy chain") to route in conduit to the second wall-mount unit. Connect both drain wires with wire nut.





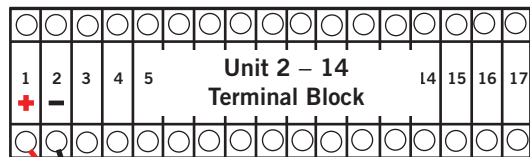
**FIGURE 31**  
**Communication Wiring: Termination at Additional Wall-Mount Units**



Wall-Mount Unit 2

1. Route the cable from the first wall-mount unit to the terminal block of the second wall-mount unit. If this is the last unit to be connected, make a small service loop and attach EMI filter as shown.

2. Connect the wires matching the terminal designations (+/-) of the controller terminals. Cap the loose drain with a wire nut or electrical tape.

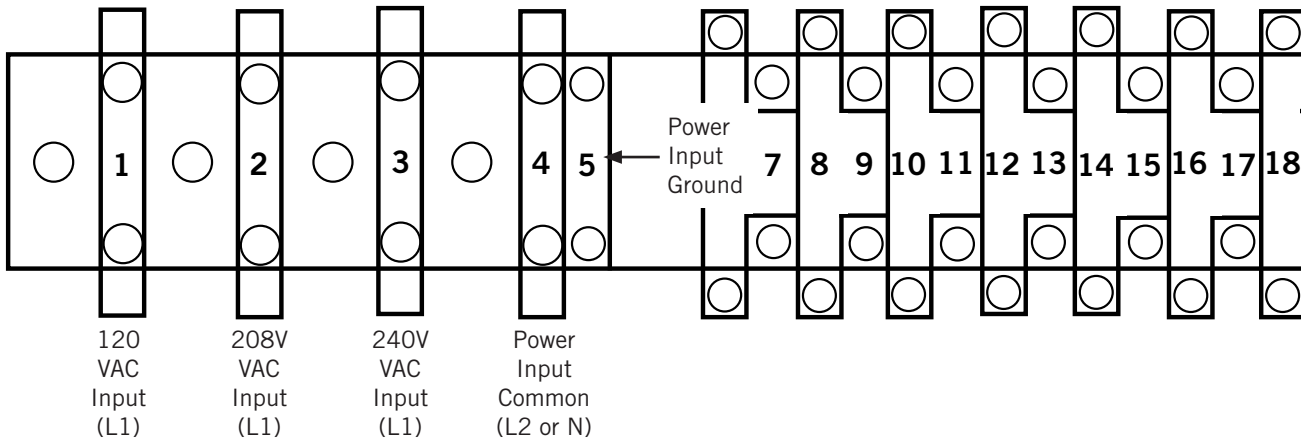


3. Continue daisy chaining units by connecting "+" to "+", "-" to "-" and wire nutting drain together until last unit which is capped with a wire nut. **Attach EMI filter as shown above at last unit.** Up to 14 wall-mount units can be connected and controlled by one LC6000 controller.

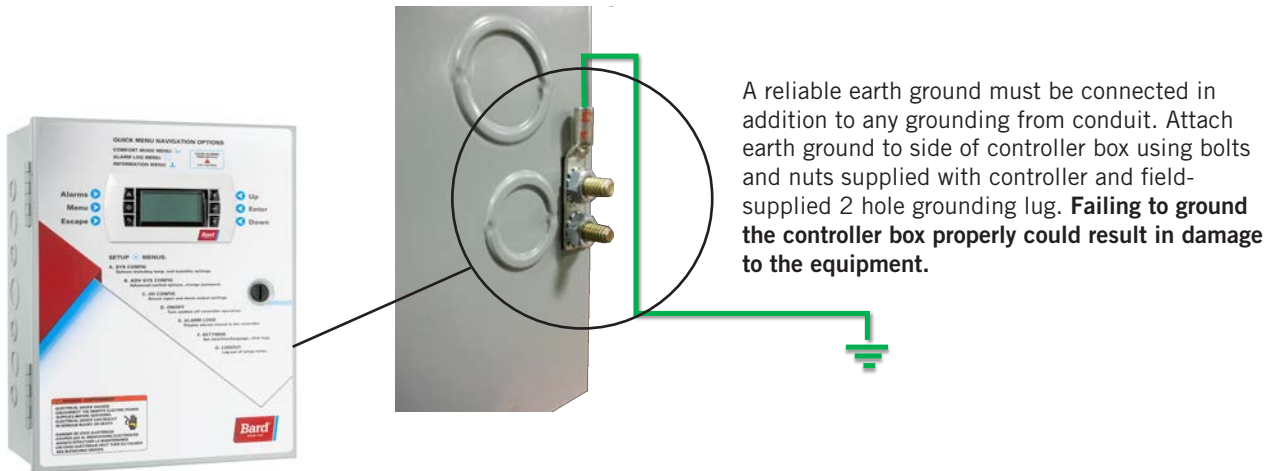
## Supply Wiring

The LC6000 controller is powered by 120, 208 or 240 volts from the shelter. Field-supplied supply wiring should be minimum 16 gauge, maximum 14 gauge (see Figure 32). A reliable earth ground must be connected in addition to any grounding from conduit. Grounding bolts and nuts are included with the controller for this purpose; a 2 hole grounding lug must be field supplied. Install as shown in Figure 33. **Failing to ground the controller box properly could result in damage to the equipment.**

**FIGURE 32**  
**LC6000 Controller Supply Wiring**



**FIGURE 33**  
**Controller Grounding Posts**

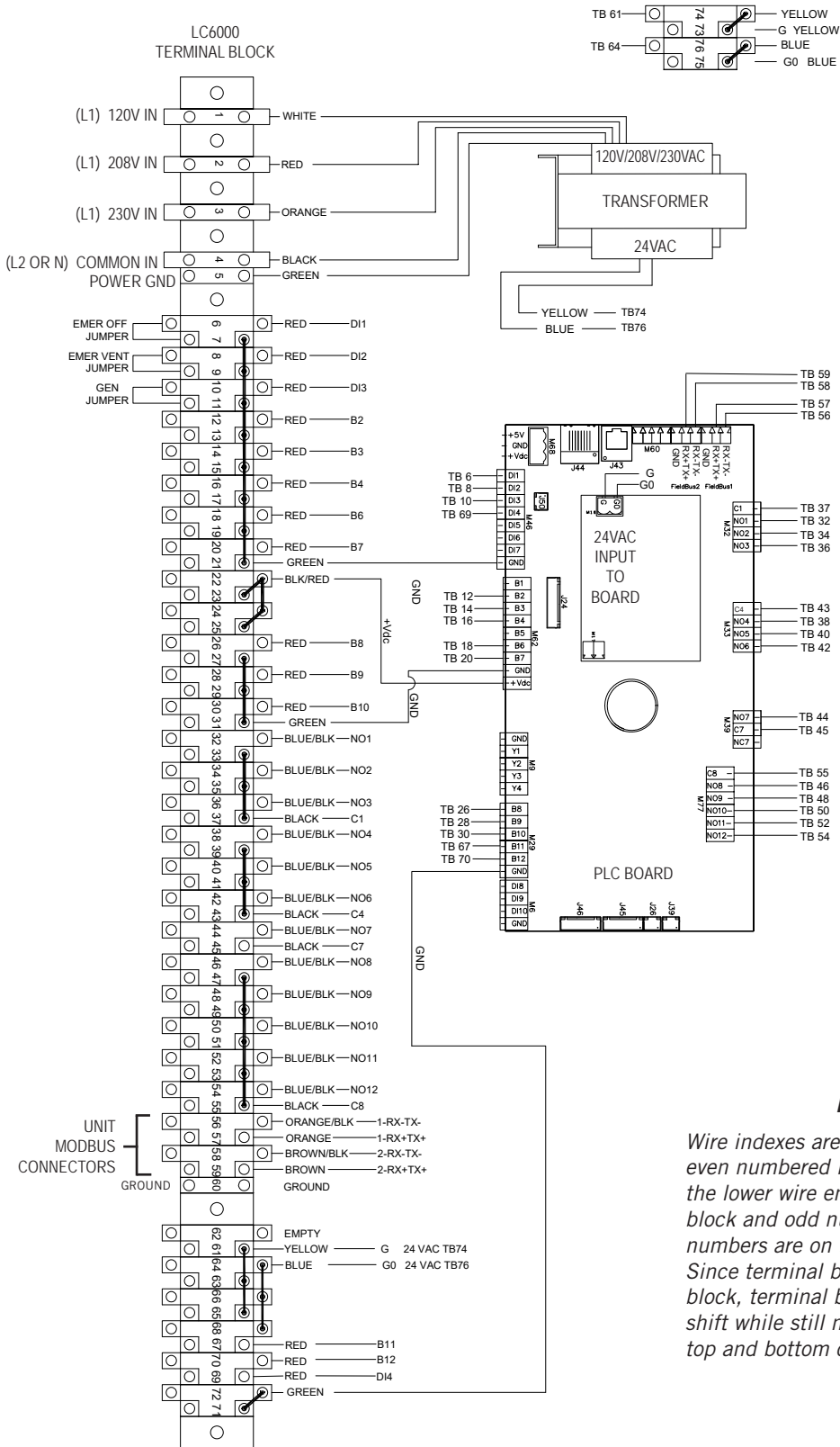


**TABLE 4**  
**LC6000-200 Terminal Block Index**

TB#	Wire Mark	Description
1	-	120 VAC Input
2	-	208 VAC Input
3	-	230 VAC Input
4	-	Power Input Common
5	-	Power Input Ground
6	DI1	Emergency Off Input
7	GND	Emergency Off Common
8	DI2	Emergency Vent Input
9	GND	Emergency Vent Common
10	DI3	Generator Run Input
11	GND	Generator Run Common
12	B2	Zone 1 Indoor Remote Humidity Sensor
13	GND	Ground
14	B3	Zone 2 Indoor Remote Humidity Sensor
15	GND	Ground
16	B4	Zone 3 Indoor Remote Humidity Sensor
17	GND	Ground
18	B6	Zone 1 Indoor Temperature Sensor
19	GND	Ground
20	B7	Zone 1 Indoor Remote Temperature Sensor
21	GND	Ground
22	VDC+	Power for B2 (Z1 Humidity)
23	VDC+	Power for B3 (Z2 Humidity)
24	VDC+	Power for B4 (Z3 Humidity)
25	VDC+	Power for B10 (Pressure)
26	B8	Zone 2 Indoor Remote Temperature Sensor
27	GND	Ground
28	B9	Zone 3 Indoor Remote Temperature Sensor
29	GND	Ground
30	B10	Indoor Space Pressure
31	GND	Ground
32	NO1	Humidifier 1
33	C1	Common
34	NO2	Humidifier 2
35	C1	Common
36	NO3	Humidifier 3
37	C1	Common
38	NO4	Emergency Off Alarm

TB#	Wire Mark	Description
39	C4	Common
40	NO5	Emergency Vent Alarm
41	C4	Common
42	NO6	Generator Run Alarm
43	C4	Common
44	NO7	Indoor Humidity Alarm
45	C7	Common
46	NO8	High Indoor Temperature Alarm
47	C8	Common
48	NO9	Low Indoor Temperature Alarm
49	C8	Common
50	NO10	Zone 1 Unit Alarm
51	C8	Common
52	NO11	Zone 2 Unit Alarm
53	C8	Common
54	NO12	Zone 3 Unit Alarm
55	C8	Common
56	FB1R-	RS485 RX- / TX- (Fieldbus 1) <b>UNIT CONNECTION</b>
57	FB1R+	RS485 RX+ / TX+ (Fieldbus 1) <b>UNIT CONNECTION</b>
58	FB2R-	RS485 RX- / TX- (Fieldbus 2)
59	FB2R+	RS485 RX+ / TX+ (Fieldbus 2)
60	--	Power Input Ground
61	24 VAC+	24 VAC Supply
62	--	Not Used
63	24 VAC+	24 VAC Supply
64	24 VAC-	24 VAC Ground
65	24 VAC+	24 VAC Supply for Outdoor Humidity Sensor
66	24 VAC-	24 VAC Ground for Outdoor Humidity Sensor
67	B11	Signal for Outdoor Humidity Sensor
68	24 VAC+	24 VAC Supply
69	D14	Bard Guard Alarm Signal
70	B12	Signal for Outdoor Temperature Sensor
71	GND	Ground for Outdoor Temperature Sensor
72	GND	Ground for Bard Guard Alarm Signal
73	G	Orange Power Connector
74	24 VAC+	24 VAC Supply
75	G0	Orange Power Connector
76	24 VAC-	24 VAC Ground

**FIGURE 34**  
**LC6000-200 Wiring Diagram**



**NOTE:**

Wire indexes are identified such that even numbered index numbers are on the lower wire entries of the terminal block and odd numbered index numbers are on the top wire entries. Since terminal block 60 is a ground block, terminal blocks 61 thru 72 shift while still maintaining the same top and bottom configuration.

The LC6000 controller and TEC-EYE hand-held diagnostic tool will both be used to set up the Bard air conditioning system.

## TEC-EYE™ Hand-Held Diagnostic Tool

The microprocessor control used in the WR Series wall-mount air conditioners allows for complete control and monitoring through the use of the provided TEC-EYE hand-held monitor.

The menu driven interface provides users the ability to scroll through two menu levels: Quick Menu and Main Menu. The menus permit the user to easily view, control and configure the unit. See latest version of WR Series Service Instructions manual 2100-695 for more information on using the TEC-EYE.

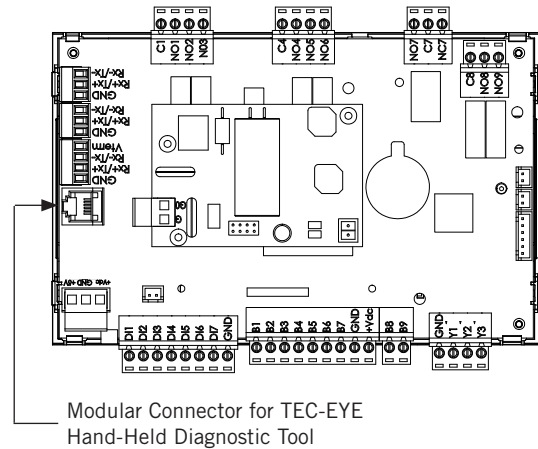
The TEC-EYE connects to the wall-mount unit control board via an RJ11 modular connector as shown in Figure 35.

When not being used, the TEC-EYE hand-held diagnostic tool should be stored inside or near the LC6000 controller. Do not let the TEC-EYE leave the shelter.

### TEC-EYE Status Screen

The Status screen is the default start-up screen and also the return screen after 5 minutes of no activity. The screen can be accessed any time by pressing the ESCAPE key repeatedly.

**FIGURE 35**  
TEC-EYE Connection to Unit Control



The wall-mount unit address is displayed in the upper right corner on the Status screen (see Figure 36). The Status screen also shows the current date, time, return air temperature, mixed air temperature, outdoor air temperature, outdoor humidity and outdoor dew point conditions. Blower speed, condenser fan speed, damper position and unit status are also displayed. See Table 6 on page 46 for wall-mount unit status messages.

**FIGURE 36**  
TEC-EYE (Bard P/N 8301-059) Display and Interface (Status Screen Shown)



#### ALARM KEY

Allows viewing of active alarms  
Silences audible alarms  
Resets active alarms

#### MENU KEY

Allows entry to Main Menu

#### ESCAPE KEY

Returns to previous menu level  
Cancels a changed entry

#### UP KEY

Steps to next screen in the display menu  
Changes (increases) the value of a modifiable field

#### ENTER KEY

Accepts current value of a modifiable field  
Advances cursor

#### DOWN KEY

Steps back to previous screen in the display menu  
Changes (decreases) the value of a modifiable field

**NOTE:** Screenshots shown in this manual reflect default settings (when applicable).

# NOTICE

**It is important to check the software version during installation to ensure that the latest version has been installed. Current software versions and installation instructions are available on the Bard website at <http://www.bardhvac.com/software-download/>**

## Setting Up Wall-Mount Units for Operation

The TEC-EYE hand-held diagnostic tool is needed to set up the wall-mount unit(s).

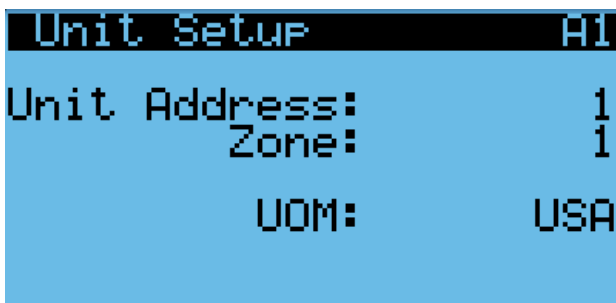
### 1. Address Each Wall-Mount Unit

Each unit must have a unique address for the system to operate correctly with the LC controller (Ex: 1, 2, 3, ...14 depending on the number of units). The unit only needs the address to be changed for the communication to work properly. The wall-mount unit address is displayed in the upper right corner on the Status screen on the TEC-EYE display (see Figure 36 on page 37).

To change the unit address:

- 1) Press MENU key to access the Main Menu screen.
- 2) Press UP or DOWN keys and ENTER key to enter TECHNICIAN password 1313.
- 3) Press UP or DOWN keys to scroll to **Sys Config**; press ENTER key.
- 4) Press ENTER key to scroll to **Controller Address** (see Figure 37).
- 5) Press UP or DOWN keys to change the address to a value between 1 and 14.

**FIGURE 37**  
Changing Unit Setup Values



**NOTE:** Each unit must have a unique address for the communication to work properly. Bard also recommends labeling each unit for ease in identification.

In addition to setting up the address, the user may also want to set the unit of measure (UOM), zone and economizer control type. Unit addresses can only be used once per LC6000 regardless of number of zones.

To change these settings:

- 1) Press MENU key to access the Main Menu screen.
- 2) Press UP or DOWN keys and ENTER key to enter TECHNICIAN password 1313.
- 3) Press UP or DOWN keys to scroll to **Sys Config**; press ENTER key.
- 4) Press ENTER key to scroll to **UOM** (see Figure 37).
- 5) If desired, press UP or DOWN keys to change the value from **USA** to **SI**, **NC**, **LON**, **CAN** or **UK**. Units are preconfigured for each selection.
- 6) Press ENTER key to scroll to **Zone**.
- 7) If desired, press UP or DOWN keys to change value.
- 8) Press ENTER key to save.

Basic wall unit parameter settings are now set and the unit is ready to communicate with the LC.

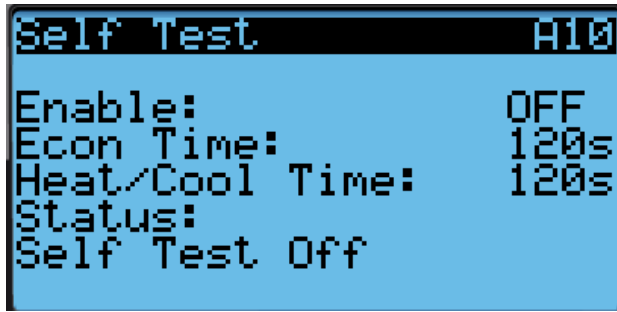
### 2. Execute a Self Test on Each Unit

Execute a self test on each unit to verify the equipment is functioning correctly. Some unit parameters are adjustable.

- 1) Press MENU key to access the Main Menu screen.
- 2) Press UP or DOWN keys and ENTER key to enter TECHNICIAN password 1313.
- 3) Press UP or DOWN keys to scroll to **Sys Config**; press ENTER key.
- 4) Press UP key to scroll to **Self Test A10** screen.
- 5) Press ENTER key to scroll to **Enable** (see Figure 38).
- 6) Press UP or DOWN key to change value to **ON**. The self test will begin and the screen will display the status of the self test.



**FIGURE 38**  
Executing Self Test



**Self Test Parameter Description**

Econ Stage Time: Amount of time (in seconds) allowed for damper blade movement in each direction.

Cool Stage Time: Amount of time (in seconds) allowed for each stage of cooling.

Heat Stage Time: Amount of time (in seconds) allowed for heating stage.

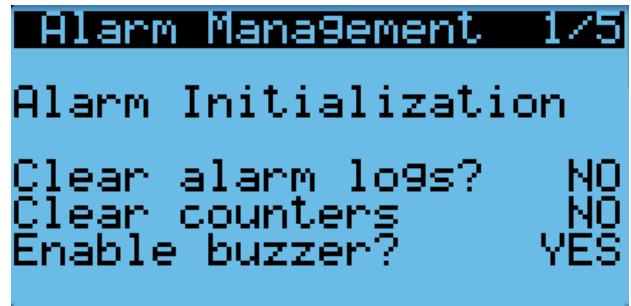
**3. Clear Unit Alarm Logs on Each Unit**

Units may have alarms logged due to testing. Unit alarm logs must be cleared at time of installation.

To clear the wall-mount unit alarm logs:

- 1) Press MENU key to go to the Main Menu screen.
- 2) Use UP or DOWN keys and ENTER key to enter TECHNICIAN password 1313.
- 3) Press UP or DOWN keys to scroll to **Settings**; press ENTER key.
- 4) Press UP or DOWN keys to scroll to **Initialization**; press ENTER key.
- 5) Press ENTER key to scroll to **Clear alarm logs?** (see Figure 39).
- 6) Press UP or DOWN key to value to **YES**; press ENTER key.
- 7) Press ESCAPE key several times to return to Main Menu screen.

**FIGURE 39**  
Clearing Unit Alarm Logs



After each of the wall-mount units have been addressed, had a self test performed and had the alarm logs cleared, the rest of the system set up can proceed.

**Setting Up LC6000 for Operation**

The LC6000 controller will be used for the remaining steps in the set up process.

**LC6000 Status Screen**

The Status screen is the default start-up screen and also the return screen after 5 minutes of no activity on the LC6000. The screen can be accessed any time by pressing the ESCAPE key repeatedly.

The Status screen on the LC6000 displays the current date, time, unit displayed, zones and system status (see Figure 40).

**4. Set LC Controller Date and Time**

- 1) Press MENU key to access the Main Menu screen.
- 2) Use UP or DOWN keys and ENTER key to enter USER password 2000.
- 3) Press the UP or DOWN keys to scroll to the **Settings** menu; press ENTER key.
- 4) Press UP or DOWN keys to scroll to **Date/Time** menu; press ENTER key.
- 5) Press UP or DOWN keys to scroll to **Date/Time change**.

**FIGURE 40**  
LC6000 Controller Display and Interface (Status Screen Shown)



LC6000 interface key functions are the same as those shown for the TEC-EYE in Figure 36 on page 37.

- 6) Press ENTER key to scroll to the desired value to be changed (see Figure 41).
- 7) Press UP or DOWN keys to change the value.
- 8) Press ENTER key to save and to scroll to top of screen.
- 9) Press UP or DOWN keys to scroll to **Timezone** (if applicable). Follow steps 6-8 to change timezone.
- 10) Press ESCAPE key several times to return to Main Menu screen.

**NOTE:** The LC6000 will sync the time and date configured to each of the wall-mount units once communication is established.

**FIGURE 41**  
Setting Controller Date and Time



## 5. Configure Sensors

The system will need to be configured for the number of temperature and humidity sensors installed. The system is shipped with one combination temperature and humidity sensor. Additional combination sensors may be purchased or alternatively, temperature-only sensors may be purchased instead. The LC is capable of utilizing five temperature sensors and four humidity sensors. The system will need to be configured for the various configurations.

If necessary, the sensors could be calibrated at this time too. For information on calibrating the sensors (adjusting the offset), see page 45.

To enable/disable **Zone 1 Indoor Humidity**:

- 1) Press MENU key to go to the Main Menu screen.
- 2) Press UP or DOWN keys and ENTER key to enter USER password 2000.
- 3) Press UP or DOWN keys to scroll to **IO Config**; press ENTER key.
- 4) Press UP or DOWN keys to scroll to **Z1 Indoor Hum C4**.
- 5) Press ENTER key to scroll to **Enable** (see Figure 42).

- 6) Press UP or DOWN key to change value to ON to enable sensor (or change value to OFF to disable sensor).

**FIGURE 42**  
Enable/Disable Zone 1 Indoor Humidity Sensor



To enable/disable **Zone 2 Indoor Humidity**:

- 1) Press MENU key to go to the Main Menu screen.
- 2) Press UP or DOWN keys and ENTER key to enter USER password 2000.
- 3) Press UP or DOWN keys to scroll to **IO Config**; press ENTER key.
- 4) Press UP or DOWN keys to scroll to **Z2 Indoor Hum C5**.
- 5) Press ENTER key to scroll to **Enable** (see Figure 43).
- 6) Press UP or DOWN key to change value to ON to enable sensor (or change value to OFF to disable sensor).

**FIGURE 43**  
Enable/Disable Zone 2 Indoor Humidity Sensor



To enable/disable **Zone 3 Indoor Humidity**:

- 1) Press MENU key to go to the Main Menu screen.
- 2) Press UP or DOWN keys and ENTER key to enter USER password 2000.
- 3) Press UP or DOWN keys to scroll to **IO Config**; press ENTER key.

- 4) Press UP or DOWN keys to scroll to **Z3 Indoor Hum C6**.
- 5) Press ENTER key to scroll to **Enable** (see Figure 44).
- 6) Press UP or DOWN key to change value to ON to enable sensor (or change value to OFF to disable sensor).

**FIGURE 44**  
Enable/Disable Zone 3 Indoor Humidity Sensor



To enable/disable **Zone 1 Indoor Temperature**:

- 1) Press MENU key to go to the Main Menu screen.
- 2) Use UP or DOWN keys and ENTER key to enter USER password 2000.
- 3) Press UP or DOWN keys to scroll to **IO Config**; press ENTER key.
- 4) Press UP or DOWN keys to scroll to **Z1 Indoor Temp C7**.
- 5) Press ENTER key to scroll to **Enable** (see Figure 45).
- 6) Press UP or DOWN key to change value to ON to enable sensor (or change value to OFF to disable sensor).

**FIGURE 45**  
Enable/Disable Zone 1 Indoor Temperature Sensor

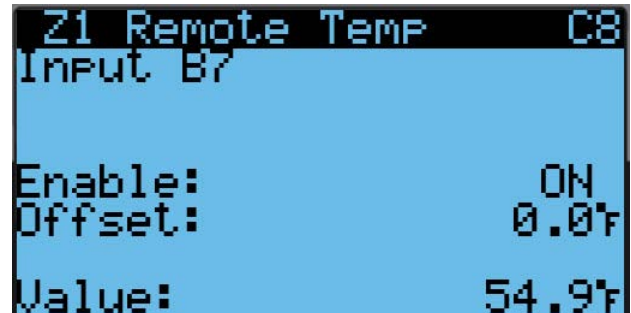


To enable/disable **Zone 1 Remote Temperature**:

- 1) Press MENU key to go to the Main Menu screen.

- 2) Use UP or DOWN keys and ENTER key to enter USER password 2000.
- 3) Press UP or DOWN keys to scroll to **IO Config**; press ENTER key.
- 4) Press UP or DOWN keys to scroll to **Z1 Remote Temp C8**.
- 5) Press ENTER key to scroll to **Enable** (see Figure 46).
- 6) Press UP or DOWN key to change value to ON to enable sensor (or change value to OFF to disable sensor).

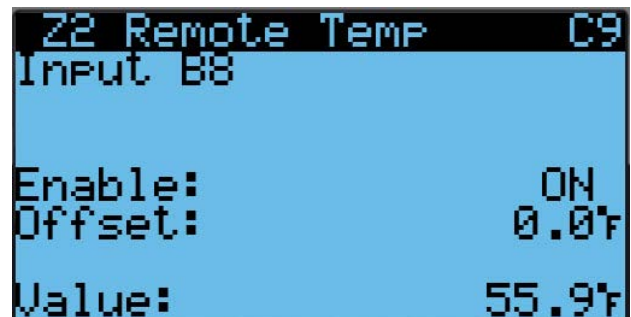
**FIGURE 46**  
Enable/Disable Zone 1 Remote Temperature Sensor



To enable/disable **Zone 2 Remote Temperature**:

- 1) Press MENU key to go to the Main Menu screen.
- 2) Use UP or DOWN keys and ENTER key to enter USER password 2000.
- 3) Press UP or DOWN keys to scroll to **IO Config**; press ENTER key.
- 4) Press UP or DOWN keys to scroll to **Z2 Remote Temp C9**.
- 5) Press ENTER key to scroll to **Enable** (see Figure 47).
- 6) Press UP or DOWN key to change value to ON to enable sensor (or change value to OFF to disable sensor).

**FIGURE 47**  
Enable/Disable Zone 2 Remote Temperature Sensor

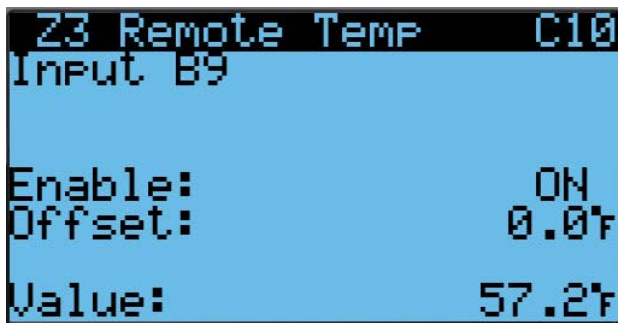


To enable/disable **Zone 3 Remote Temperature**:

- 1) Press MENU key to go to the Main Menu screen.
- 2) Use UP or DOWN keys and ENTER key to enter USER password 2000.
- 3) Press UP or DOWN keys to scroll to **IO Config**; press ENTER key.
- 4) Press UP or DOWN keys to scroll to **Z3 Remote Temp C10**.
- 5) Press ENTER key to scroll to **Enable** (see Figure 48).
- 6) Press UP or DOWN key to change value to ON to enable sensor (or change value to OFF to disable sensor).

**FIGURE 48**

**Enable/Disable Zone 3 Remote Temperature Sensor**

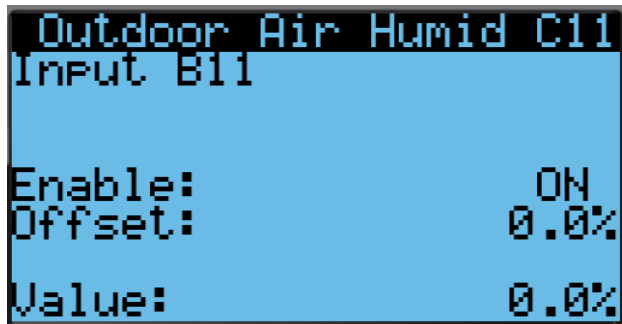


To enable/disable **Outdoor Air Humidity**:

- 1) Press MENU key to go to the Main Menu screen.
- 2) Use UP or DOWN keys and ENTER key to enter USER password 2000.
- 3) Press UP or DOWN keys to scroll to **IO Config**; press ENTER key.
- 4) Press UP or DOWN keys to scroll to **Outdoor Air Humid C11**.
- 5) Press ENTER key to scroll to **Enable** (see Figure 49).
- 6) Press UP or DOWN key to change value to ON to enable sensor (or change value to OFF to disable sensor).

**FIGURE 49**

**Enable/Disable Outdoor Air Humidity Sensor**

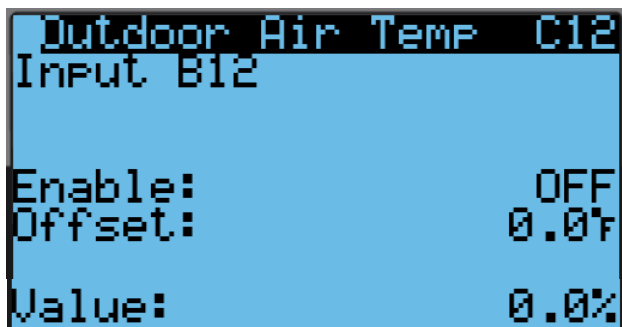


To enable/disable **Outdoor Air Temperature**:

- 1) Press MENU key to go to the Main Menu screen.
- 2) Use UP or DOWN keys and ENTER key to enter USER password 2000.
- 3) Press UP or DOWN keys to scroll to **IO Config**; press ENTER key.
- 4) Press UP or DOWN keys to scroll to **Outdoor Air Temp C12**.
- 5) Press ENTER key to scroll to **Enable** (see Figure 50).
- 6) Press UP or DOWN key to change value to ON to enable sensor (or change value to OFF to disable sensor).

**FIGURE 50**

**Enable/Disable Outdoor Air Temperature**

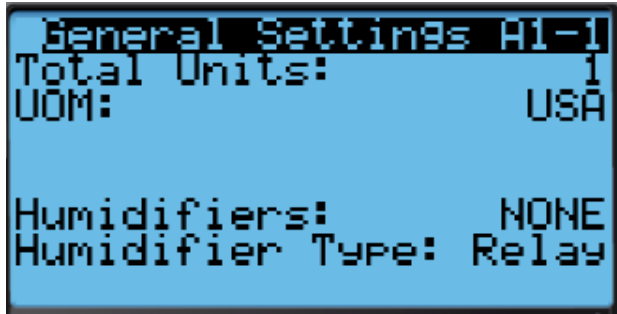


#### 6. Enter Total Number of Units

- 1) Press MENU key to go to the Main Menu screen.
- 2) Press UP or DOWN keys and ENTER key to enter USER password 2000.
- 3) Press UP or DOWN keys to scroll to **Sys Config**; press ENTER key.
- 4) Press UP or DOWN keys to scroll to **General**; press enter key.

- 5) Press ENTER key to scroll to **Total Units** (see Figure 51).
- 6) Press UP or DOWN keys to adjust value to correct number of units.
- 7) Press ENTER key to save value.
- 8) Press the ESCAPE key several times to return to Main Menu screen.

**FIGURE 51**  
Total Units Displayed




#### 7. Verify Units Are Online

Once a unit is uniquely addressed, communication can be verified at the LC controller.

With the correct number of units set at the LC controller, each unit can be remotely viewed from the controller information screen.

To view these screens:

- 1) Press ESCAPE key to view the Status screen. (May need to be pressed more than once.)
- 2) Press UP or DOWN key until the Quick Menu in the lower right corner of the screen displays the Information icon (  ); press ENTER key.
- 3) Press UP or DOWN keys to scroll through the Information screens until the desired unit Information screen appears.

In addition to being able to remotely view the units, an alarm will be generated on the LC controller for units not communicating.

#### 8. Select Economizer Type for Each Zone

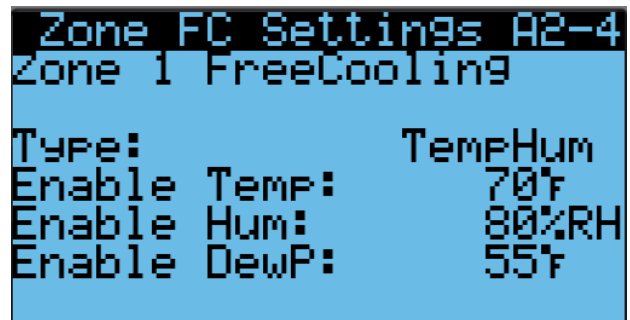
Each zone can be configured to operate the economizers with different considerations. For more information on the different economizer choices, reference the most recent version of FUSION-TEC WR Series Service Instructions 2100-695.

The type of consideration can be set to none, dry bulb, temperature and humidity or enthalpy. These settings will be communicated to the wall units while connected to the LC6000 to ensure all units operate the same.

To select economizer type for each zone:

- 1) Press MENU key to go to the Main Menu screen.
- 2) Use UP or DOWN keys and ENTER key to enter password 1313.
- 3) Press UP or DOWN keys to scroll to **Sys Config**; press ENTER key.
- 4) Press UP or DOWN keys to scroll to **Zone 1**, **Zone 2** or **Zone 3**; press ENTER key.
- 5) Press UP or DOWN keys to scroll to **Zone FC Settings A2-4** (Zone 1), **Zone FC Settings A3-4** (Zone 2) or **Zone FC Settings A4-4** (Zone 3).
- 6) Press ENTER key to scroll to **Type** (see Figure 52).
- 7) Press UP or DOWN keys to change economizer type to **None**, **Drybulb**, **TempHum** or **Enthalpy**.
- 8) Press ENTER key to save.

**FIGURE 52**  
Selecting Economizer Type



#### 9. Clear Controller Alarm Logs

The LC6000 controller may have alarms logged due to bench testing. Controller alarm logs must be cleared at time of installation.

To clear the LC controller alarm logs:

- 1) Press MENU key to go to the Main Menu screen.
- 2) Use UP or DOWN keys and ENTER key to enter USER password 2000.
- 3) Press UP or DOWN keys to scroll to **Settings**; press ENTER key.
- 4) Press UP or DOWN keys to scroll to **Initialization**; press ENTER key.
- 5) Press ENTER key to scroll to **Delete alarm logs?** (see Figure 53 on page 44).
- 6) Press UP or DOWN key to value to **YES**; press ENTER key.
- 7) Press ESCAPE key several times to return to Main Menu screen.

**FIGURE 53**  
**Clearing LC6000 Alarm Logs**

```
EInitialization
Alarm initialization
Delete alarm logs?      NO
Clear AutoReset
counters?               NO
Enable buzzer?         YES
```

#### **10. Complete Installation**

Once all the installation steps have been completed, all alarms and alarm logs have been cleared and system verification and self test results were satisfactory, the installation can now be considered "complete".

Additional programming information can be found in the most recent versions of FUSION-TEC WR Series Service Instructions 2100-695 and LC6000 Service Instructions 2100-669.



# ADDITIONAL INFORMATION

## Menu Screens and Password Levels

### WR Series Unit

- System Config: A1-A10 User (2000)
- Adv. System Config: B1-B8 Technician (1313)
- I/O Config: C1-C15 Technician (1313)
- On/Off: User (2000)
- Alarm Logs: User (2000)
- Settings
  - Date/Time: Technician (1313)
  - Language: User (2000)
  - Import/Export
    - Unit Parameters: Engineer (9254)
    - Alarm Log Export: User (2000)
    - 7 Day Log Export: User (2000)
  - Initialization
    - Alarm Management: User (2000)
    - System Default: Engineer (9254)
  - Change Passwords
- Logout: Used to log out of the current password level. Entering back into the menu requires password.

### LC1000 Controller

- System Config
  - General: User (2000)
  - Zone 1: User (2000)
  - Zone 2: User (2000)
  - Zone 3: User (2000)
- Adv. System Config: B1-B13 Technician (1313)
- I/O Configuration: C1-C10 Technician (1313)
- On/Off: User (2000)
- Alarm Log: User (2000)
- Settings
  - Date/Time: Technician (1313)
  - Language: User (2000)
  - Network Config: Technician (1313)
  - Initialization
    - Clear Logs: User (2000)
    - System Default: Engineer (9254)
    - Restart: User (2000)
    - Parameter Config: Engineer (9254)
    - Alarm Export: User (2000)
- Logout: Used to log out of the current password level. Entering back into the menu requires password.

## Setpoints

The *LC6000* setpoints will determine the cooling and heating setpoints when *communicating with the wall-mount units*. The *unit* cooling and heating setpoints will determine the cooling and heating setpoints when *in orphan mode*.

If at any time the unit(s) loses communication with the LC6000 controller, the unit(s) will go into orphan mode.

## Calibrating Sensors

1. Press MENU key on LC controller interface to go to the Main Menu screen.
2. Use UP or DOWN keys and ENTER key to enter USER password 2000.
3. Press UP or DOWN keys to scroll to **I/O Config**; press ENTER key.
4. Press UP or DOWN keys to scroll to sensor to be adjusted.
5. Press ENTER key to scroll to **Offset** (see Figure 54).
6. Press UP or DOWN keys to add or subtract to the sensor offset value.
7. Press ENTER key to save.

**FIGURE 54**  
Adjusting Sensor Offset Value



**TABLE 5**  
LC6000/TEC-EYE Passwords (Defaults)

User	2000
Technician	1313
Engineer	9254
Use UP or DOWN keys and ENTER key to enter password	

**TABLE 6**  
**WR Series Wall-Mount Unit Status Messages**

Message	Description
Waiting...	PLC is on and has not started running the application yet.
Orphan Mode	Unit is on and in orphan mode with no calls for heating or cooling.
LC Online	Unit is on and communicating with the LC6000 with no heating or cooling calls.
Cont. Blower	Unit is operating with continuous blower when no heating or cooling calls are present.
Power Loss	Unit has experienced a loss of main utility power. Alarm only available with inverter units.
Freecooling	Unit is actively economizing.
Optimized Cool	Unit is mechanical cooling while actively economizing.
Cooling	Unit is actively mechanical cooling.
Heating	Unit is actively heating.
Passive Dehum	Unit is taking measures to decrease humidity without using extra energy.
Active Dehum	Unit is taking active measures to decrease humidity.
Self Test	Unit is performing a self test.
Off by Alarm	Unit has major fault preventing operation.
Off by DI	Unit is disabled by the local unit disable input.
Off by LC	Unit has been turned off by the supervisory controller.
Off by Keyboard	Unit has been turned off by the local user.
Override Active	There is an active override on the system.
Emergency Vent	Unit is in Emergency Ventilation. LC6000 has an active hydrogen alarm.
Emergency Cool	Unit is in Emergency Cooling. Indoor temperatures have exceeded high temp alarms.
Emergency Off	Unit is in Emergency Off. LC6000 Emergency Off input indicates an alarm.

**TABLE 7**  
**LC6000 Status Messages**

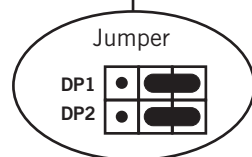
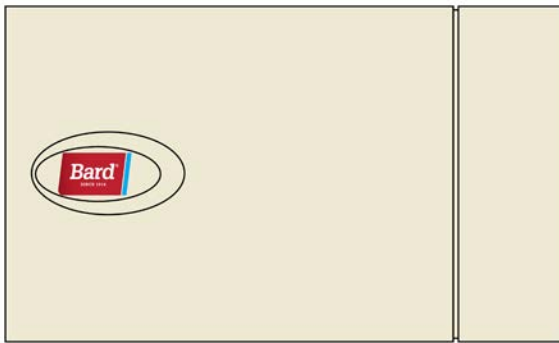
Message	Description
On	The LC6000 is ready and functioning properly.
Off by BMS	The LC6000 is being turned off by the Building Management System through Modbus TCP/IP.
Off by Keyboard	The LC6000 is turned off using the (D. On/Off) Menu on the PGD. All communicating units will be inactive.
Comfort Mode	The LC6000 is set to Comfort Mode. This mode is used to temporarily override heating/cooling setpoints and maintain a default temperature of 72°F for 60 minutes.
Emergency Cooling	A high temperature has been sensed in one or more zones. All available units in that zone are sent a command for emergency cooling. (Refer to unit manual for emergency cooling sequence.)
Emergency Vent	Input signal from an external device at terminal DI2 (e.g., hydrogen detector). Units that are equipped with a ventilation option and configured will open the dampers at 100% with the blower at full speed.

## Remote Indoor Temperature/Humidity Sensor Orientation

Current versions of the remote indoor temperature/humidity sensor need to be installed with the shielded cable wires entering the bottom of the back of the sensor to connect to the sensor terminals (see Figure 55). Earlier versions of this sensor were installed so that the sensor wires entered through the top of the back of the sensor (see Figure 56). **The orientation of the sensor affects the position of the DP1/DP2 jumpers. Depending on how the sensor is installed, be sure to confirm that the jumpers are in the proper position for the 0-1 V setting as shown in the figures below.**

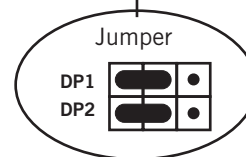
This applies to all indoor temperature/humidity sensors connected to the LC controller. See illustration mounted inside of sensor cover for further detail on jumper position.

**FIGURE 55**  
Current Sensor Orientation  
(Shielded Cable Wires Enter from Bottom)



DP1 and DP2 Jumpers  
Positioned for 0-1V  
(Current Orientation)

**FIGURE 56**  
Earlier Sensor Orientation  
(Shielded Cable Wires Enter from Top)



DP1 and DP2 Jumpers  
Positioned for 0-1V  
(Earlier Orientation)